

■ Connectivity Solutions

LÜTZE Connectivity Solutions

Cable Assemblies
Actuator Sensor Interface
Suppression Technology

Efficiency in Automation

Cable • Connectivity • Cabinet • Control

Welcome to LÜTZE

Cable Solutions



Connectivity Solutions



Cabinet Solutions



Control Solutions



Transportation Solutions



LÜTZE - Efficiency in Automation

A tradition in automation for over 60 years, with countless pioneering achievements and patents, the LÜTZE INTERNATIONAL Group is today one of the leading companies in the automation industry. LÜTZE supplies very efficient electronic and electrotechnical components, system solutions for automation and high tech for rail engineering.

The comprehensive and coordinated supply program ranges from high flexing cables and cable assemblies, to energy efficient **AirSTREAM** wiring systems for control cabinets through to intelligent Industry 4.0 solutions from the fields of interface technology, current monitoring, power supply and Ethernet infrastructure.

The LÜTZE INTERNATIONAL Group has multiple locations throughout Europe, Asia and the USA and numerous distribution partners across the world to provide global product availability and service to our customers in all markets.

LÜTZE is one of the leading suppliers in the rail technology field. LÜTZE Transportation solutions are installed in numerous locomotives, city rail and underground rail systems, as well as high-speed trains across the world.

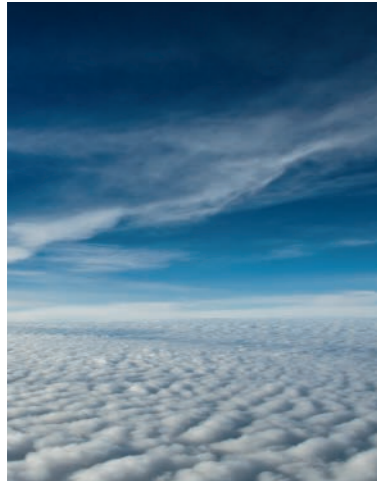

Business Management: Sustainable and forward-looking

“The competitiveness of our industry and of its suppliers depends quite substantially on how we succeed in developing practical results. The results that we produce together today, are our competitive advantages in the future.”
Udo LÜTZE,
Member of the Executive Committee of
the Green Carbody Innovation Alliance

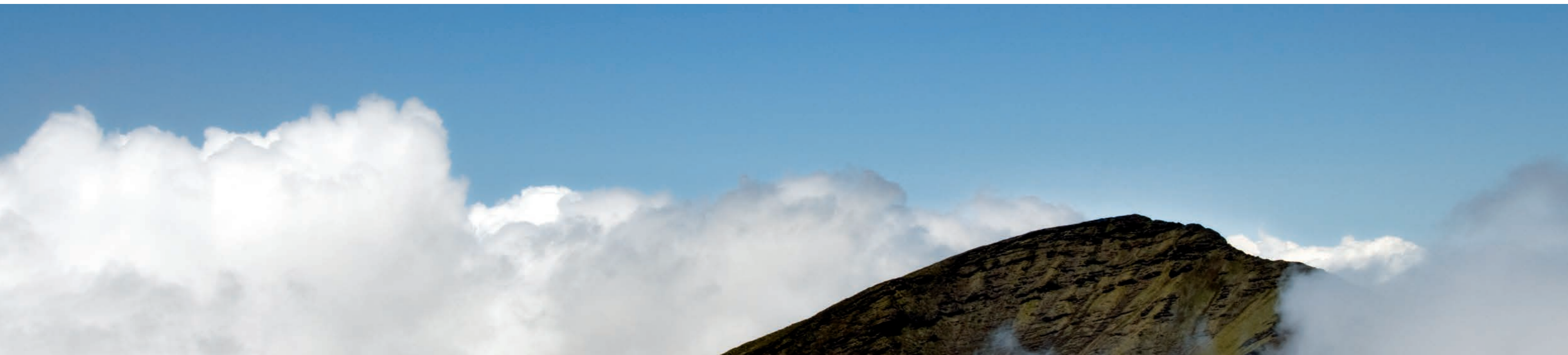

The future is blue

Sustainable enterprise means thinking and planning ahead, understanding and embedding the belief that long lasting success is more important than short-term profit maximisation.

This is an attitude that has existed within LÜTZE for quite some time. Economic and environmental responsibilities complement each other well and are reflected in the sustainable management and

product policy - and from now in the SkyBLUE campaign.

We manufacture our products in a resourceful and energy-conscious manner. We use long lasting, environmentally-friendly materials.

And our products, in turn, help our customers save energy and resources. Good for everyone: for us, for the environment, for our customers a win-win-win situation.

Goods with real value

The value of a product or a solution from LÜTZE is determined by its sustainable qualities as well. Every innovation is only as successful in the future if it has a long-term positive effect. Therefore, we provide long lasting as well as highly efficient components. We are incorporating the necessary knowledge and manufacturing competence in numerous joint projects with the objective of improving energy efficiency and

sustainable technologies and industries. Thus, LÜTZE provides answers and demonstrates how to handle resources responsibly, with our environment and our future in mind.



RoHS

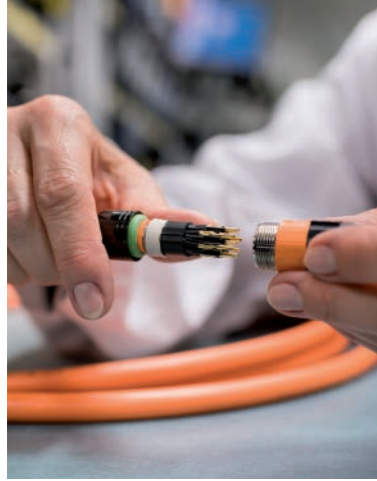

What moves us: Quality, innovation, efficiency

A prime example of competence in cables: In addition to manufacturing expertise, our cable assembly specialists are familiar with all cable types and offer genuine added value. The decisive advantage: We're cable experts – since 1958.



The people at LÜTZE

Quality, innovation and efficiency begin with people. We would not be where we are today without our highly qualified and motivated employees. An uncompromising focus on quality, 60 years of experience in automation technology and of course a common desire for greater innovation and efficiency – that's what makes LÜTZE so successful.

The people at LÜTZE are familiar with automation applications and technologies across all disciplines, as they are involved with our broad range of products comprising four product areas Cable, Connectivity, Cabinet and Control.



INDUSTRY 4.0

IIoT - Industrial Internet of Things

What is Industry 4.0?

A German government memo released way back in 2013 was one of the first times that 'Industrie 4.0' was mentioned.

The high-tech strategy document outlined a plan to almost fully computerise the manufacturing industry without the need for human involvement.

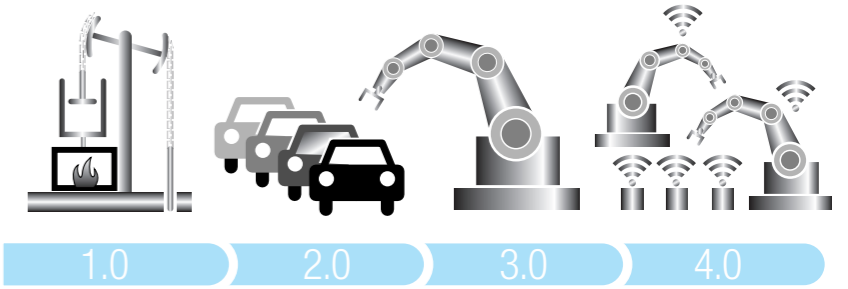

The first industrial revolution was the one that saw the transition from farming to factory production in the 19th Century. The second ran from around the 1850s, and began with the introduction of steel, culminating in the early electrification of factories and the first signs of mass production.

In more recent times is the third industrial revolution that refers to the change from analogue, mechanical, and electronic technology to digital technology that took place from the late 1950s to the late 1970s.



Industry 4.0 is another area where the Internet of Things looks to play a huge role thanks to the sheer volume of sensors and "things" that have the potential to feed information into it and add value to manufacturing processes. Projections on the industry have mentioned the IoT alongside

cyber-physical systems as ways in which a combination of software, sensors, processors and communications technology will underpin the very development of Industry 4.0.

LÜTZE Connectivity

The smart machines of the future need reliable connections. LÜTZE has a large range of industrial ethernet cables and connectors and is capable of producing cable assemblies that provide users of automation equipment with the connections they need, using either RJ45, M12 or M8 connectors.

Smart electronic current control from LÜTZE

The control equipment on machines needs DC voltage, so the monitoring of these circuits is a logical next step as part of the IIoT concept.

The LOCC-Box devices from LÜTZE can provide complete information from the machine load circuits and communicate this information via

Ethercat/Profinet to facilitate external monitoring at either the machine level and or remotely.

Contents



Cable assemblies 14

Assemblies for servo drive systems

Construction questionnaire for Connectivity 16 - 17

Construction questionnaire for LÜTZE SAFECON 18

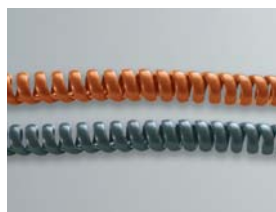

Customer specific solutions

Construction questionnaire for coil cables 19

Coil cables 20

Customer specific solutions

Allen-Bradley* 21 - 25

Beckhoff 26

Bosch Rexroth* 27 - 31

SIEMENS* 32 - 53

Pre-assembled cables

SIEMENS Simatic S7 54



Actuator sensor interface 58

Actuator sensor cables / Actuator sensor valve suppressors 59 - 94

Connectors, assembled freely 95 - 110

Module holder RJ45 female / IDC 111

Panel connectors RJ45, USB 3.0 112 - 118

Accessories 119

Classification Ethernet Cable and - connector 120 - 123



Suppression technology 126

Suppressor for Switching Gear 127 - 130

Valve connectors 131 - 154

Motor suppression 155 - 161

Technical information 163

Part number index 178 - 179

Product photos

The product photos are not to scale and do not accurately depict every single product detail.



Cable assemblies



Cable assemblies



Allen-Bradley® according to 2090 Standard for stationary applications

Servo motor cable	21
Feedback cable	22

for c-tracks

Hybrid cables OTC	23
Servo motor cable	24
Feedback cable	25



Beckhoff Standard

for c-tracks

Hybrid cables OTC	26
-------------------	----



Bosch Rexroth® Standard

for c-tracks

Hybrid cables OCT	27
Servo motor cable according to IKG Standard	28
Servo motor cable according to RKL Standard	29 - 30
Feedback cable according to IKS/RKG Standard	31



SIEMENS® according to 6FX5002 for c-tracks

Hybrid cables OCT	32
-------------------	----

SIEMENS® according to 6FX5002 for stationary applications

Base cable	33
Servo cable assemblies without brake, Base cable	34 - 35
Servo cable assemblies with brake, Base cable	36 - 37
Servo cable assemblies without brake, Extension	38 - 39
Feedback cable DRIVE-CLIQ®, Base cable	40 - 42

SIEMENS® according to 6FX8002 for c-tracks

Base cable	43
Servo cable assemblies without brake, Base cable	44 - 45
Servo cable assemblies with brake, Base cable	46 - 47
Servo cable assemblies without brake, Extension	48
Servo cable assemblies with brake, Extension	49
Feedback cable DRIVE-CLIQ®, Base cable	50 - 52
Feedback cable, Base cable, Extension	53

Product photos

The product photos are not to scale and do not accurately depict every single product detail.

Cable assemblies



Pre-assembled cables for various applications

Siemens Simatic SPS / S7 connector

54

Product photos

The product photos are not to scale and do not accurately depict every single product detail.

Ordering instructions

The LÜTZE Art.no. consists of two blocks that are separated by a dot:

6-digits before the dot: technical design

4-digits after the dot: length code in cm

Special features:

- No minimum order quantity
- All intermediate lengths in increments of 0.5 m are available within a short time
- When ordering, please specify serial number and length key
- Additional types on request

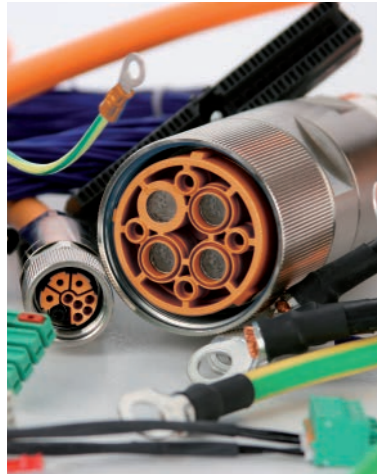

Always the right connection: LÜTZE cable assemblies

Helical cables - Manufactured to meet your specifications, our helical cables are suitable for high mechanical loads such as high-performance machines, lifting



platforms and lots of other moving applications. Also highly suited for use outside for millions of load changes without failure!



Moduled closed

LÜTZE SAFECON plastic moulded round plug connectors M23 for industrial use offer the user an economical and, at the same time, safe solution for the electrical connection of machines and systems.

The LÜTZE program contains various termination numbers and cable lengths. This means terminations of 6 - 28 and transfer outputs of up to 30 A at 630 V, and

therefore robust, safe cabling is available for numerous signal and power applications.

The integrated protection against kinking and the inner metal housing with 360° EMC shielding ensure the cable assemblies meet the requirements for the industrial sector - **they really are sealed shut!**

Other benefits:

- Tamper-proof: unauthorised opening of the connector housing and incorrect connection in the connector are therefore excluded
- 100 % compatible with SIEMENS®, BOSCH REXROTH®, ALLEN BRADLEY®
- Manufacture from a batch size of 1
- Available at short notice
- Protection class IP66/67

Customer-specific solutions

Each installation is different. Therefore, make use of our cable assembly expertise; experts will plan your project and document your application making use of a

product range containing more than 1700 cables, connectors, strain relief elements and protective hoses.



Customer questionnaire Connectivity

Company: _____
 Contact person: _____
 Department: _____
 Street address: _____
 Postal code, city/town: _____
 Telephone: _____
 Fax / E-Mail: _____



Deutschland
 Friedrich Lütze GmbH
 Tel.: +49 71 51 60 53-0
 Fax: +49 71 51 60 53-277(-288)
 info@luetze.de

Great Britain
 LUTZE Ltd.
 Tel.: +44 1827 31333-0
 Fax: +44 1827 31333-2
 sales.gb@lutze.co.uk

Manufacture

Description: _____
 Batch sizes / Delivery time /
 scale quantities: _____ -date: _____
 Annual requirement: _____

Cable

Name /
 Description: _____
 Jacket material: _____ Operating conditions: _____
 Jacket color: _____ Length (m): _____
 Approvals: _____

Side A

Connectors
 Name /
 description: _____
 Supplier: _____
 Supplier item number: _____

Machined open end
 Name /
 description: _____
 Stepped dimensions /
 wire lengths: _____
 Contacts /
 connectors: _____
 Supplier item number: _____

Cut off smoothly
 labelled not labelled

Side A

Connectors
 Name /
 description: _____
 Supplier: _____
 Supplier item number: _____

Machined open end
 Name /
 description: _____
 Stepped dimensions /
 wire lengths: _____
 Contacts /
 connectors: _____
 Supplier item number: _____

Cut off smoothly
 labelled not labelled

General special features _____

Customer questionnaire Connectivity

Description side A

Description side B

Pin assignment

- View connection side
- View machining side

Non-used wires

- insulate
- cut off

Cable outlet

- straight
- angled in PIN direction: _____

Code settings

In direction: _____

Screen machining

- | | | |
|--|--------------------------|--------------------------|
| | outside | inside |
| Cut off | <input type="checkbox"/> | <input type="checkbox"/> |
| On housing | <input type="checkbox"/> | <input type="checkbox"/> |
| On PIN | <input type="checkbox"/> | <input type="checkbox"/> |
| Execute with wire | <input type="checkbox"/> | <input type="checkbox"/> |
| Insulate outer screen against inner screen | | <input type="checkbox"/> |
| Connect inner screen | | <input type="checkbox"/> |
| Insulate inner screens against each other | | <input type="checkbox"/> |
| Cut off outer screen, put on jacket | | <input type="checkbox"/> |
| Screen window | | <input type="checkbox"/> |
| Width: _____ | | |
| Position: _____ | | |

Label text

Wire printing available on request

Label position

After connector (mm): _____

Assignment

PIN	Wire no./colour	PIN	Wire no./colour

PIN assignment

- View connection side
- View machining side

Non-used wires

- insulate
- cut off

Cable outlet

- straight
- angled in PIN direction: _____

Code settings

In direction: _____

Screen machining

- | | | |
|--|--------------------------|--------------------------|
| | outside | inside |
| Cut off | <input type="checkbox"/> | <input type="checkbox"/> |
| On housing | <input type="checkbox"/> | <input type="checkbox"/> |
| On PIN | <input type="checkbox"/> | <input type="checkbox"/> |
| Execute with wire | <input type="checkbox"/> | <input type="checkbox"/> |
| Insulate outer screen against inner screen | | <input type="checkbox"/> |
| Connect inner screens | | <input type="checkbox"/> |
| Insulate inner screens against each other | | <input type="checkbox"/> |
| Cut off outer screen, put on jacket | | <input type="checkbox"/> |
| Screen window | | <input type="checkbox"/> |
| Width: _____ | | |
| Position: _____ | | |

Label text

Wire printing available on request

Label position

After connector (mm): _____

Special test parameter: _____
Packaging: _____

Construction questionnaire for LÜTZE SAFECON

Company: _____
 Contact person: _____
 Department: _____
 Street address: _____
 Postal code, city/town: _____
 Telephone: _____
 Fax: _____



Germany
 Friedrich Lütze GmbH
 Tel.: +49 7151 6053-0
 Fax: +49 7151 6053-277(-288)
 info@luetze.de

Great Britain
 LUTZE Ltd.
 Tel.: +44 1827 31333-0
 Fax: +44 1827 31333-2
 sales.gb@lutze.co.uk

Please tell us your requirements by filling in this construction questionnaire:

Batch size: _____ pieces

Page 1

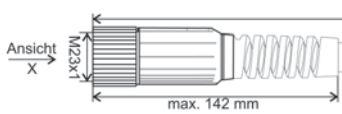

Page 2

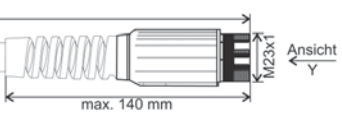

Page 1 / View X

clockwise
 counterclockwise

Signal

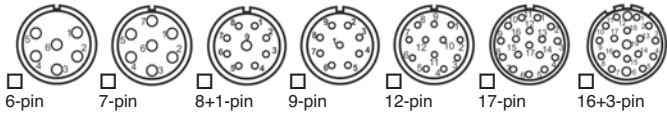

Pin layouts (more on request)

Power

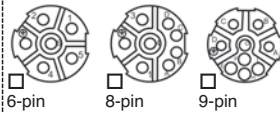

Options

Connector – inner thread M23 x 1
 Connector – speedtec quick release fastener
 Coupling – outer thread M23 x 1
 Coupling – speedtec quick release fastener
 Socket contacts pin contacts
 Signal coding: 0° 80° 120° 20°

Cable

Assembly length L: _____ mm

LÜTZE cable part number: _____
 Description / Requirement / Purpose / Specification:

Page 2 / View Y

clockwise
 counterclockwise

Signal

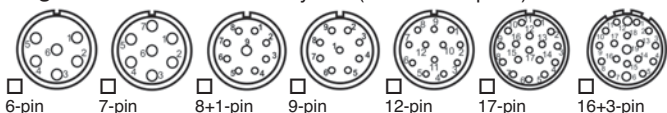

Pin layouts (more on request)

Power

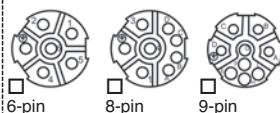

Options

Connector – inner thread M23 x 1
 Connector – speedtec quick release fastener
 Coupling – outer thread M23 x 1
 Coupling – speedtec quick release fastener
 Socket contacts pin contacts
 Signal coding: 0° 80° 120° 20°
 Other connectors Type/Version: _____
 Manufacturer: _____
 Manufacturer part number: _____

Manipulation cable end (strip, remove insulation, change screen, shrink tubing, copper tape etc.) –
 Description: _____

Cable end cut smoothly

Labelling

Wrap-round label printing text distance to connector: _____
 Cable printing text distance to connector: _____
 Other labelling – Description: _____
 No labelling

Note: Please indicate pin assignment!

Construction questionnaire for Coil cables

Company: _____
 Contact person: _____
 Department: _____
 Street address: _____
 Postal code, city/town: _____
 Telephone: _____
 Fax: _____



Germany
 Friedrich Lütze GmbH
 Tel.: +49 7151 6053-0
 Fax: +49 7151 6053-277(-288)
 info@luetze.de

Great Britain
 LUTZE Ltd.
 Tel.: +44 1827 31333-0
 Fax: +44 1827 31333-2
 sales.gb@luetze.co.uk

Please let us know your requirements using this design questionnaire for coil cables:

L: _____ mm L0: _____ mm
 Ø AD: _____ mm Ø WD: _____ mm
 L1: _____ mm L2: _____ mm
 L3: _____ mm L4: _____ mm
 L5: _____ mm L6: _____ mm
 Quantity: _____ pcs.

Purpose

Installation situation: _____

Winding direction: _____

Standard cable art. no.: _____

Jacket insulation material: _____

Number of strands: _____

Strand cross-section: _____ mm²

Shielding: yes no

Please fill out this questionnaire and fax it back to us. We will be happy to give you a quotation.

Thank you!

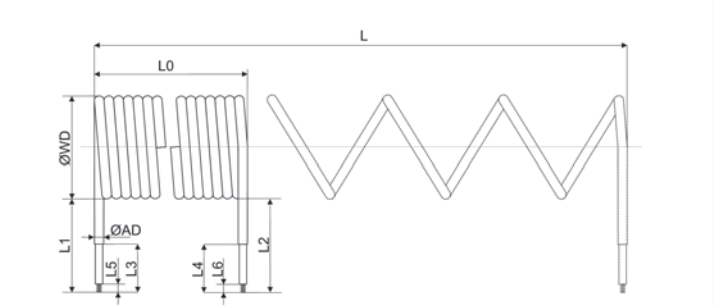

Cable outlets, radial

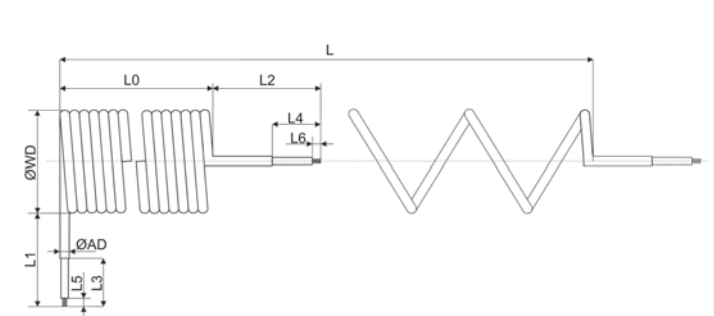

Cable outlets, radial and axial

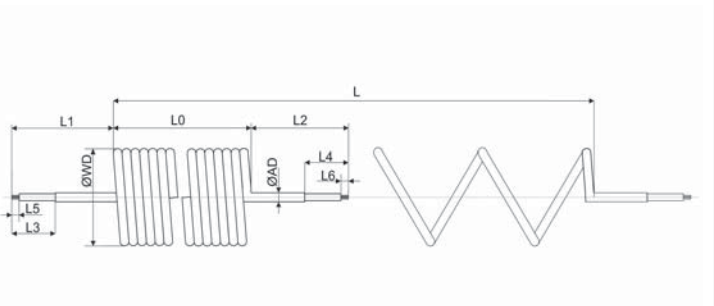

Cable outlets, axial

Comments

PUR Coil cables - unshielded

LÜTZE PURFLEX



Application

- Machine and device construction, transport and conveyor technology under harsh operating conditions
- Especially for industrial environments, machines and plants
- Lifting platforms, test benches and measuring systems as well as door drives

Properties

- Very good restoring force
- Low adhesion, abrasion-resistant, nick-resistant, tear-resistant
- Hydrolysis-resistant, microbe-resistant, and rot-resistant
- Weathering, ozone and UV resistant (normal lighting conditions)
- Industrial and salt water resistant
- Largely resistant to oils, greases, alcohol-free benzines and kerosene

- Free from paint wetting disruptive substances (LABS-free)
- RoHS compliant

Construction

Jacket material PUR
Surface matte, adhesion-free

Technical data

Rated voltage U_0/U 300/500 V
Temperature range moving -20 °C ... +80 °C
Temperature range fixed -40 °C ... +80 °C
Design Cable outlet radial

Part No.	Number of conductors/cross-section	Spiral diameter mm	Spiral length mm	Max. extension length mm	Connection ends L1/L2	Conductor marking	Jacket color
PURFLEX							
190003	A* 3G1.5	30	500	2,250	250/250 mm	green/yellow • brown • blue	orange RAL 2003
190007	A* 3G1.5	30	1,000	4,000	250/250 mm	green/yellow • brown • blue	orange RAL 2003
190012	A* 3G1.5	30	1,500	5,750	250/250 mm	green/yellow • brown • blue	orange RAL 2003
190016	A* 3G1.5	30	2,000	7,500	250/250 mm	green/yellow • brown • blue	orange RAL 2003
190004	A* 4G1.5	33	500	2,250	250/250 mm	green/yellow • brown • black • grey	orange RAL 2003
190008	A* 4G1.5	33	1,000	4,000	250/250 mm	green/yellow • brown • black • grey	orange RAL 2003
190013	A* 4G1.5	33	1,500	5,750	250/250 mm	green/yellow • brown • black • grey	orange RAL 2003
190017	A* 4G1.5	33	2,000	7,500	250/250 mm	green/yellow • brown • black • grey	orange RAL 2003
190005	A* 5G1.5	40	500	2,250	250/250 mm	green/yellow • blue • brown • black • grey	orange RAL 2003
190009	A* 5G1.5	40	1,000	4,000	250/250 mm	green/yellow • blue • brown • black • grey	orange RAL 2003
190014	A* 5G1.5	40	1,500	5,750	250/250 mm	green/yellow • blue • brown • black • grey	orange RAL 2003
190018	A* 5G1.5	40	2,000	7,500	250/250 mm	green/yellow • blue • brown • black • grey	orange RAL 2003
190560	A* 7G1.5	46	2,000	7,500	600/600 mm	black • with white number print	orange RAL 2003
190006	A* 12G1.5	70	500	2,250	250/250 mm	black • with white number print	black RAL 9005
190010	A* 12G1.5	70	1,000	4,000	250/250 mm	black • with white number print	black RAL 9005
190015	A* 12G1.5	70	1,500	5,750	250/250 mm	black • with white number print	black RAL 9005
190019	A* 12G1.5	70	2,000	7,500	250/250 mm	black • with white number print	black RAL 9005

Servomotor Cable Assemblies for fixed installation

According to Allen-Bradley 2090 standard

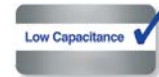

Application

- Especially for industrial environments in mechanical and system engineering
- Reinforced insulation with additional relief layer
- Based on NFPA 79 standards
- TC-ER for use in machines and open cable ducts
- UL Type 1000 V Flexible Motor Supply Cable for connection to motors
- In dry, damp and wet rooms

Properties

- Wire insulation reinforcing layer protects against premature cable failure due to reduced corona effect and therefore improves reliability and the life span
- Flexible wires with nylon for better resistance to pressure and impacts as per UL 1277
- High flexibility for complex installation distances and small bending radii
- Improved oil resistance due to specifically developed TPE jacket
- UV-resistant
- Silicone free
- RoHS compliant

Construction

Jacket material TPE
Surface matte, adhesion-free
Jacket color orange RAL 2003

Temperature range fixed
Temperature range moving
Minimum bending radius fixed
Minimum bending radius moving
Certifications

1000 V WTTC
600 V UL TC
600 V UL MTW
600 V UL AWM 105 °C
-40 °C ... +90 °C (105 °C)
-5 °C ... +90 °C
6xD
15xD

UL Flexible Motor Supply Cable
UL Type WTTC 1000 V
UL Type TC-ER
MTW 600 V
UL AWM Style 20328
RoHS
REACH
Class 1 Div. 2 per NEC
Art. 336, 392, 501
C(UL) TC and CIC FT4
UL 1277
Oil Res I and II

* Allen-Bradley article designations are registered trademarks of Rockwell Allen Bradley, and are for reference purposes only

Technical data

Rated voltage U_N 1000 V Flexible Motor Supply

Note

Part No.	Allen Bradley designation*	Cable length m	Number of conductors/cross-section	Outer Ø mm
Base cable speed-connect				
193966.1000	A* 2090-CPWM7DF-16AA10	10.0	(4GAWG16)	10.5
193356.1000	A* 2090-CPBM7DF-12AA10	10.0	(4GAWG12+(2×AWG18))	14.2
193352.1000	A* 2090-CPWM7DF-12AA10	10.0	(4GAWG12)	13.1
193306.1000	A* 2090-CPWM7DF-10AA10	10.0	(4GAWG10)	16.5
193353.1000	A* 2090-CPWM7DF-08AA10	10.0	(4GAWG8)	21.0
193960.1000	A* 2090-CPBM7DF-16AA10	10.0	(4GAWG16+(2×AWG18))	12.1
193990.1000	A* 2090-CPBM7DF-14AA10	10.0	(4GAWG14+(2×AWG18))	12.8
193956.1000	A* 2090-CPWM7DF-14AA10	10.0	(4GAWG14)	11.6
193362.1000	A* 2090-CPBM7DF-04AA10	10.0	(4GAWG4+(2×AWG18))	29.5
193357.1000	A* 2090-CPBM7DF-08AA10	10.0	(4GAWG8+(2×AWG18))	22.5
193961.1000	A* 2090-CPBM7DF-06AA10	10.0	(4GAWG6+(2×AWG18))	24.6
193962.1000	A* 2090-CPBM7DF-10AA10	10.0	(4GAWG10+(2×AWG18))	18.1
193369.1000	A* 2090-CPBM7DF-02AA10	10.0	(4GAWG2+(2×AWG18))	34.1

Signal Cable Assemblies for fixed installation

According to Allen-Bradley 2090 standard

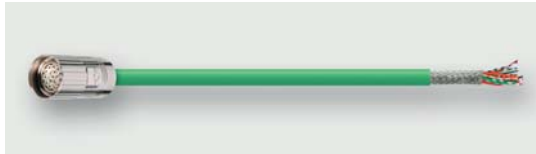

Application

- Feedback cables for Allen-Bradley drives
- Conform with NFPA79 for machine tool wiring
- Very suitable for extreme operating conditions and high interference signals
- In dry, damp and wet rooms
- Especially for industrial environments, machines and plants

Properties

- High active and passive interference resistance (EMC)
- Easy installation
- Specially developed TPE jacket for superior oil-resistance according to UL 1581
- Largely resistant to mineral and vegetable-based cutting oils
- UV-resistant
- Talc free and silicone free
- RoHS compliant

Construction

Jacket material TPE
Jacket color green RAL 6018

Technical data

Rated voltage U_n 300 V UL
600 V UL AWM 90 °C
Temperature range fixed -40 °C ... +90 °C (105 °C)
Temperature range moving -5 °C ... +90 °C
Minimum bending radius fixed 6×D
Minimum bending radius moving 15×D
Oil resistant according to UL 1581
Oil resistance 4 days in oil at 100 °C
60 days in oil at 75 °C

Burning behavior according to UL Vertical-Tray
UL VW-1

Certifications UL
cURus

Note

* Allen-Bradley article designations are registered trademarks of Rockwell Allen Bradley, and are for reference purposes only

Part No.	Allen Bradley designation*	Cable length m	Number of conductors/cross-section	Outer Ø mm
Base cable speed-connect				
193959.1000	A* 2090-CFBM7DF-CEAA10	10.0	(5×2×AWG22)	9.9
193358.1000	A* 2090-CFBM7DD-CEAA10	10.0	(5×2×AWG22)	9.9
Base cable full thread				
193337.1000	A* 2090-XXNFMF-S10	10.0	(2×AWG16+2×AWG22 +6×2×AWG26)	13.6

Single Cable Assemblies for C-tracks

According to Allen-Bradley 2090 standard



Application

- Combined power supply cable with motor supply, brake and digital feedback especially for SERVO drives in machine and plant construction, transport and conveyor technology
- Through full PUR jacket and TPE conductor insulation optimally suited for c-tracks, extremely harsh operating conditions and aggressive coolants and lubricants
- Especially for industrial environments, machines and plants

Properties

- High active and passive interference resistance (EMC)
- Braided shield optimised for continuous flexing use
- Very good alternating bending strength
- Low adhesion, abrasion-resistant, nick-resistant, tear-resistant
- Hydrolysis-resistant, microbe-resistant, and rot-resistant
- Weathering, ozone and UV resistant (normal lighting conditions)
- Industrial and salt water resistant
- Excellent coolant and lubricant resistance
- Largely resistant to oils, greases, alcohol-free benzines and kerosene
- Halogen free
- Talc free and silicone free
- RoHS compliant

Construction

Jacket material Special PUR
Surface matte, adhesion-free
Jacket color orange RAL 2003

Technical data

Rated voltage U_N 1000 V 80 °C
Temperature range fixed -40 °C ... +80 °C
Temperature range moving -25 °C ... +80 °C
Minimum bending radius fixed 5xD
Minimum bending radius moving 7.5xD
Burning behavior according to IEC 60332-1
DIN EN 50265-2
VDE 0482 Part 265-2
UL 1581 part 1080 VW-1
UL FT1
EN 50267-2-1

Halogen free according to Certifications

Note

Note

cURus
UL AWM 21223
max. cable length according to Allen-Bradley specifications
Base cable for Kinetix® 5500 Drives max. 50 m
Base cable for Kinetix® 5700 Drives max. 90 m
Extension cable max. 30 m
* Allen-Bradley article designations are registered trademarks of Rockwell Allen Bradley, and are for reference purposes only

Part No.	Allen Bradley designation*	Cable length m	Number of conductors/cross-section	Outer Ø mm
Base cable speed-connect				
193366.1000	A* 2090-CSBM1DF-18AF10	10.0	(4G1.0+(2×0.75)+(2×AWG22))	11.8
193364.1000	A* 2090-CSBM1DF-14AF10	10.0	(4G2.5+(2×1.0)+(2×AWG22))	14.0
193371.1000	A* 2090-CSWM1DF-18AF10	10.0	(4G1.0+(2×AWG22))	11.8
193370.1000	A* 2090-CSWM1DF-14AF10	10.0	(4G2.5+(2×AWG22))	14.0
193375.1000	A* 2090-CSBM1DF-10AF10	10.0	(4G6+(2×1.0)+(2×AWG22))	17.8
193376.1000	A* 2090-CSWM1DF-10AF10	10.0	(4G6+(2×AWG22))	17.8
Base cable with 2198-KITCON-DSL				
193952.1000	A* 2090-CSBM1DE-18AF10	10.0	(4G1.0+(2×0.75)+(2×AWG22))	11.8
193963.1000	A* 2090-CSBM1DE-14AF10	10.0	(4G2.5+(2×1.0)+(2×AWG22))	14.0
193379.1000	A* 2090-CSWM1DE-18AF10	10.0	(4G1.0+(2×0.75)+(2×AWG22))	11.8
193955.1000	A* 2090-CSWM1DE-14AF10	10.0	(4G2.5+(2×1.0)+(2×AWG22))	14.0
193968.1000	A* 2090-CSBM1DE-10AF10	10.0	(4G6+(2×1.0)+(2×AWG22))	17.8
193967.1000	A* 2090-CSWM1DE-10AF10	10.0	(4G6+(2×1.0)+(2×AWG22))	17.8
Extension speed-connect				
193373.1000	A* 2090-CSBM1E1-18AF10	10.0	(4G1.0+(2×0.75)+(2×AWG22))	11.8
193374.1000	A* 2090-CSBM1E1-14AF10	10.0	(4G2.5+(2×1.0)+(2×AWG22))	14.0

Servomotor Cable Assemblies for C-tracks

According to Allen-Bradley 2090 standard



Application

- Servo cables for Allen-Bradley drives
- Through optimized cable construction optimally suited for continuous flexing applications in C-tracks
- Very good resistance against aggressive coolants and lubricants
- Especially for industrial environments in mechanical and system engineering

Properties

- High active and passive interference resistance (EMC)
- Silicone free
- RoHS compliant

Construction

Jacket material
Surface
Jacket color

PUR
matte, adhesion-free
orange RAL 2003

Rated voltage U_N
Temperature range fixed
Temperature range moving
Minimum bending radius fixed
Minimum bending radius moving
Burning behavior according to

1000 V 80 °C
-40 °C ... +80 °C
-25 °C ... +80 °C
6×D
10×D
IEC 60332-1
VDE 0482 Part 265-2
UL 1581 part 1080 VW-1
UL FT1
EN 50267-2-1

Halogen free according to
Certifications

Note

cURus
UL AWM 21223
* Allen-Bradley article designations are registered trademarks of Rockwell Allen Bradley, and are for reference purposes only

Technical data

Part No.	Allen Bradley designation*	Cable length m	Number of conductors/cross-section	Outer Ø mm
Base cable speed-connect				
193309.1000	A* 2090-CPWM7DF-16AF10	10.0	(4G1.5)	8.6
193307.1000	A* 2090-CPWM7DF-10AF10	10.0	(4G6.0)	14.0
193989.1000	A* 2090-CPBM7DF-10AF10	10.0	(4G6.0+(2×1.5))	16.1
193991.1000	A* 2090-CPBM7DF-16AF10	10.0	(4G1.5+(2×1.5))	11.4
193308.1000	A* 2090-CPWM7DF-14AF10	10.0	(4G2.5)	10.8
193957.1000	A* 2090-CPBM7DF-14AF10	10.0	(4G2.5+(2×1.5))	12.9
193311.1000	A* 2090-CPWM7DF-08AF10	10.0	(4G10)	17.6
193355.1000	A* 2090-CPBM7DF-08AF10	10.0	(4G10+(2×1.5))	19.5
Base cable full thread				
193985.1000	A* 2090-CPBM4DF-16AF10	10.0	(4G1.5+(2×1.5))	12.9
193303.1000	A* 2090-CPWM4DF-16AF10	10.0	(4G1.5)	8.6
193983.1000	A* 2090-CPBM4DF-14AF10	10.0	(4G2.5+(2×1.5))	14.2
193301.1000	A* 2090-CPWM4DF-14AF10	10.0	(4G2.5)	10.8
Extension speed-connect				
193996.1000	A* 2090-CPBM7E7-16AF10	10.0	(4G1.5+(2×1.5))	11.4
193994.1000	A* 2090-CPBM7E7-10AF10	10.0	(4G6.0+(2×1.5))	16.1
193360.1000	A* 2090-CPBM7E7-14AF10	10.0	(4G2.5+(2×1.5))	12.9
193361.1000	A* 2090-CPBM7E7-08AF10	10.0	(4G10+(2×1.5))	19.5

Signal Cable Assemblies for C-tracks

According to Allen-Bradley 2090 standard

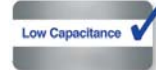
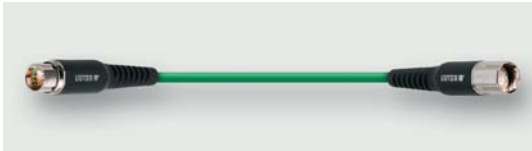

Application

- Feedback cables for Allen-Bradley drives
- Through optimized cable construction optimally suited for continuous flexing applications in C-tracks
- Very good resistance against aggressive coolants and lubricants
- Especially for industrial environments, machines and plants

Properties

- High active and passive interference resistance (EMC)
- Silicone free
- RoHS compliant

Construction

Jacket material PUR
 Surface matte, adhesion-free
 Jacket color green RAL 6018

Rated voltage U_N 1000 V 80 °C
 Temperature range fixed -40 °C ... +80 °C
 Temperature range moving -25 °C ... +80 °C
 Minimum bending radius fixed 6×D
 Minimum bending radius moving 12×D
 Burning behavior according to IEC 60332-1
 VDE 0482 Part 265-2
 UL 1581 part 1080 VW-1
 UL FT1
 EN 50267-2-1

Halogen free according to Certifications

Note

cULus
 UL AWM 21223
 * Allen-Bradley article designations are registered trademarks of Rockwell Allen Bradley, and are for reference purposes only

Technical data

Part No.	Allen Bradley designation*	Cable length m	Number of conductors/cross-section	Outer Ø mm
Base cable speed-connect				
193977.1000	A* 2090-CFBM7DF-CEAF10	10.0	(5×2×AWG22)	9.2
193958.1000	A* 2090-CFBM7DF-CDAF10	10.0	(2×AWG16+2×AWG22+6×2×AWG26)	10.8
193350.1000	A* 2090-CFBM7DD-CEAF10	10.0	(5×2×AWG22)	9.2
Base cable full thread				
193973.1000	A* 2090-CFBM4DF-CDAF10	10.0	(2×AWG16+2×AWG22+6×2×AWG26)	10.8
Extension speed-connect				
193979.1000	A* 2090-CFBM7E7-CEAF10	10.0	(5×2×AWG22)	9.2
193978.1000	A* 2090-CFBM7E7-CDAF10	10.0	(2×AWG16+2×AWG22+6×2×AWG26)	10.8

OCT hybrid cables for C-tracks

According to Beckhoff standard Single-cable Hybrid SERVO motor lines

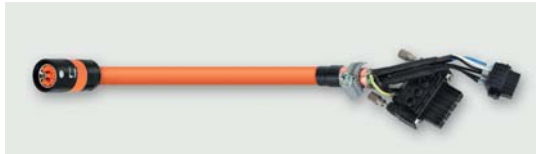

Application

- Combined power supply cable with motor supply, brake and digital feedback especially for SERVO drives in machine and plant construction, transport and conveyor technology
- Through full PUR jacket and TPE / HGI conductor insulation optimally suited for c-tracks, extremely harsh operating conditions and aggressive coolants and lubricants
- Especially for industrial environments, machines and plants

Properties

- High active and passive interference resistance (EMC)
- Braided shield optimised for continuous flexing use
- Very good alternating bending strength
- Low adhesion, abrasion-resistant, nick-resistant, tear-resistant
- Weathering, ozone and UV resistant (normal lighting conditions)
- industrial- and salt water resistant
- Excellent coolant and lubricant resistance
- Largely resistant to oils, greases, alcohol-free benzines and kerosene
- Halogen free
- Talc free and silicone free
- RoHS compliant

Construction

Jacket material
Surface

Special PUR
matte, adhesion-free

Jacket color

orange RAL 2003

Technical data

Rated voltage U_N 1000 V 80 °C
 Temperature range fixed -40 °C ... +80 °C
 Temperature range moving -25 °C ... +80 °C
 Minimum bending radius fixed 5xD
 Minimum bending radius moving 7.5xD
 Burning behavior according to IEC 60332-1
 DIN EN 50265-2
 VDE 0482 Part 265-2
 UL 1581 part 1080 VW-1
 UL FT1
 EN 50267-2-1

Halogen free according to Certifications

cURus

UL AWM 21223

max. cable lengths incl. extension based on Beckhoff standard

without motor choke max. 25 m – 35 m
 with motor choke max. 50 – 100 m
 depending on servo system

* Beckhoff article designations are registered trademarks of Beckhoff, and are for reference purposes only

Note

Note

Part No.	Beckhoff designation*	Cable length m	Number of conductors/cross-section	Outer Ø mm
Base cable speed-connect				
196938.1000	A* ZK4500-8023-0100	10.0	(4G1.5+(2×1.0)+(2×AWG22))	13.2
196955.1000	A* ZK4500-8024-0100	10.0	(4G2.5+(2×1.0)+(2×AWG22))	14.0
170430.1000	A* ZK4500-8025-0100	10.0	(4×4.0+(2×1.0)+(2×AWG22))	15.8
196495.1000	A* ZK4500-8022-0100	10.0	(4G1.0+(2×0.75)+(2×AWG22))	11.8
171395.1000	A* ZK4800-8022-0100	10.0	(4G1.0+(2×0.75)+(2×AWG22))	11.8
171523.1000	A* ZK4800-8023-0100	10.0	(4G1.5+(2×1.0)+(2×AWG22))	13.2
171743.1000	A* ZK4800-8024-0100	10.0	(4G2.5+(2×1.0)+(2×AWG22))	14.0
171744.1000	A* ZK4800-8025-0100	10.0	(4×4.0+(2×1.0)+(2×AWG22))	15.8

OCT hybrid cables for C-tracks

According to BOSCH REXROTH standard
Single-cable Hybrid SERVO motor lines



Application

- For Indramat* system (and similar)
- Termination cable motor or motor/brake especially for frequency converters and SERVO drives in machine and plant construction, transport and conveyor technology
- Through full PUR jacket and TPE / HGI conductor insulation optimally suited for c-tracks, extremely harsh operating conditions and aggressive coolants and lubricants
- Especially for industrial environments, machines and plants

Properties

- High active and passive interference resistance (EMC)
- Braided shield optimised for continuous flexing use
- Very good alternating bending strength
- Low adhesion, abrasion-resistant, nick-resistant, tear-resistant
- Weathering, ozone and UV resistant (normal lighting conditions)
- industrial- and salt water resistant
- Excellent coolant and lubricant resistance
- Largely resistant to oils, greases, alcohol-free benzines and kerosene
- Halogen free
- Silicone free
- RoHS compliant

Construction

Jacket material
Surface
Jacket color

PUR
matte, adhesion-free
orange RAL 2003

Technical data

Temperature range fixed
Temperature range moving
Minimum bending radius fixed
Minimum bending radius moving
Burning behavior according to

-40 °C ... +80 °C
-25 °C ... +80 °C
5xD
7.5xD
DIN EN 60332-1-2
IEC 60332-1-2
UL VW1, FT1
IEC 60754-1
nom.100 Ω

Halogen free according to
Impedance
Certifications

cURus
* Bosch Rexroth article designations are registered trademarks of Bosch Rexroth, and are for reference purposes only

Note

Part No.	BOSCH REXROTH designation*	Cable length m	Number of conductors/cross-section	Outer Ø mm
Base cable speed-connect				
193131.1000	A* RH2-021DBB-NN-010,0	10.0	(4G1,5+(2×0,75)+(4×AWG24))	13.3
193132.1000	A* RH2-022DBB-NN-010,0	10.0	(4G1,5+(2×0,75)+(4×AWG24))	13.3
193133.1000	A* RH2-023DBB-NN-010,0	10.0	(4G1,5+(2×0,75)+(4×AWG24))	13.3
193134.1000	A* RH2-025DBB-NN-010,0	10.0	(4G1,5+(2×0,75)+(4×AWG24))	13.3
Extension speed-connect				
193135.1000	A* RH2-521DBB-NN-010,0	10.0	(4G1,5+(2×0,75)+(4×AWG24))	13.3

Servomotor cables for C-tracks

According to Bosch Rexroth IKG standard



Application

- Motor cable for Bosch Rexroth SERVO drives
- Through full PUR jacket and TPE conductor insulation optimally suited for c-tracks, extremely harsh operating conditions and aggressive coolants and lubricants

Properties

- Silicone free
- RoHS compliant

Construction

Jacket material
Surface
Jacket color

PUR
matte, adhesion-free
orange RAL 2003

Rated voltage U_N
Temperature range fixed
Temperature range moving
Minimum bending radius fixed
Minimum bending radius moving
Burning behavior according to

1000 V 80 °C
-40 °C ... +80 °C
-25 °C ... +80 °C
6×D
10×D
IEC 60332-1
DIN EN 50265-2
VDE 0482 Part 265-2
UL 1581 part 1080 VW-1
UL FT1
EN 50267-2-1

Halogen free according to
Certifications

Note

cURus
* Bosch Rexroth article designations are registered trademarks of Bosch Rexroth, and are for reference purposes only

Technical data

Part No.	BOSCH REXROTH designation*	Cable length m	Number of conductors/cross-section	Outer Ø mm
Base cable				
193028.1000	A* IKG4115/010.0	10.0	(4G1.5+2×(2×0.75))	12.9
193029.1000	A* IKG4116/010.0	10.0	(4G2.5+2×(2×1.0))	14.2
193054.1000	A* IKG4117/010.0	10.0	(4G4+2×(2×1.5))	16.3
193055.1000	A* IKG4118/010.0	10.0	(4G6+2×(2×0.75))	18.4
193037.1000	A* IKG4175/010.0	10.0	(4G10+(2×1.0)+(2×1.5))	22.3
193030.1000	A* IKG4136/010.0	10.0	(4G6+(2×1.0)+(2×1.5))	18.4
193062.1000	A* IKG4176/010.0	10.0	(4G10+2×(2×1.5))	22.3
193031.1000	A* IKG4140/010.0	10.0	(4G1.5+2×(2×0.75))	18.4
193060.1000	A* IKG4139/010.0	10.0	(4G2.5+2×(2×0.75))	22.3
193038.1000	A* IKG4177/010.0	10.0	(4G4+(2×1.0)+(2×1.5))	12.9
193039.1000	A* IKG4215/010.0	10.0	(4G6+(2×1.0)+(2×1.5))	14.2
193077.1000	A* IKG4169/010.0	10.0	(4G10+(2×1.0)+(2×1.5))	16.3
193032.1000	A* IKG4155/010.0	10.0	(4G6+(2×1.0)+(2×1.5))	18.4
193078.1000	A* IKG4168/010.0	10.0	(4G10+(2×1.0)+(2×1.5))	22.3
193061.1000	R* IKG4172/010.0	10.0	(4G16+2×(2×1.5))	26.8
193035.1000	R* IKG4173/010.0	10.0	(4G25+2×(2×1.5))	29.3
193036.1000	R* IKG4174/010.0	10.0	(4G35+2×(2×1.5))	32.5
193033.1000	R* IKG4620/010.0	10.0	(4G25+2×(2×1.5))	29.3
193079.1000	R* IKG4621/010.0	10.0	(4G35+2×(2×1.5))	32.5

Servomotor cables for C-tracks

According to Bosch Rexroth RKL standard



Application

- Motor cable for Bosch Rexroth SERVO drives
- Through full PUR jacket and TPE conductor insulation optimally suited for c-tracks, extremely harsh operating conditions and aggressive coolants and lubricants

Properties

- Silicone free
- RoHS compliant

Construction

Jacket material
Surface
Jacket color

PUR
matte, adhesion-free
orange RAL 2003

Rated voltage U_N
Temperature range fixed
Temperature range moving
Minimum bending radius fixed
Minimum bending radius moving
Burning behavior according to

1000 V 80 °C
-40 °C ... +80 °C
-25 °C ... +80 °C
6xD
10xD
VDE 0482 Part 265-2
DIN EN 50265-2
IEC 60332-1
UL 1581 part 1080 VW-1
UL FT1
EN 50267-2-1

Halogen free according to
Certifications

Note

cURus
* Bosch Rexroth article designations are registered trademarks of Bosch Rexroth, and are for reference purposes only

Technical data

Part No.	BOSCH REXROTH designation*	Cable length m	Number of conductors/cross- section	Outer Ø mm
Base cable				
193262.1000	A* RKL0014/010.0	10.0	(4G1.0+2×(2×0.75))	12.5
193089.1000	A* RKL0015/010.0	10.0	(4G1.5+2×(2×0.75))	12.9
193090.1000	A* RKL0016/010.0	10.0	(4G1.5+2×(2×0.75))	12.9
193091.1000	A* RKL0017/010.0	10.0	(4G1.5+2×(2×0.75))	12.9
193092.1000	A* RKL0018/010.0	10.0	(4G2.5+2×(2×1.0))	14.2
193093.1000	A* RKL0019/010.0	10.0	(4G1.0+2×(2×0.75))	12.5
193095.1000	A* RKL0046/010.0	10.0	(4G2.5+2×(2×1.0))	14.2
193097.1000	A* RKL0049/010.0	10.0	(4G6+(2×1.0)+(2×1.5))	18.4
193098.1000	A* RKL0050/010.0	10.0	(4G1.5+2×(2×0.75))	12.9
193100.1000	A* RKL0052/010.0	10.0	(4G2.5+2×(2×1.0))	14.2
193101.1000	A* RKL0053/010.0	10.0	(4G1.0+2×(2×0.75))	12.5
193105.1000	A* RKL0057/010.0	10.0	(4G2.5+2×(2×1.0))	14.2
193106.1000	A* RKL0058/010.0	10.0	(4G4+(2×1.0)+(2×1.5))	16.3
193125.1000	A* RKL4300/010.0	10.0	(4G1.5+2×(2×0.75))	12.9
193107.1000	A* RKL4301/010.0	10.0	(4G1.5+2×(2×0.75))	12.9
193240.1000	A* RKL4302/010.0	10.0	(4G1.0+2×(2×0.75))	12.5
193258.1000	A* RKL4303/010.0	10.0	(4G1.0+2×(2×0.75))	12.5
193241.1000	A* RKL4306/010.0	10.0	(4G1.5+2×(2×0.75))	12.9
193273.1000	A* RKL4307/010.0	10.0	(4G1.5+2×(2×0.75))	12.9
193242.1000	A* RKL4308/010.0	10.0	(4G2.5+2×(2×0.75))	14.2
193243.1000	A* RKL4309/010.0	10.0	(4G2.5+2×(2×0.75))	14.2
193244.1000	A* RKL4310/010.0	10.0	(4G2.5+2×(2×0.75))	14.2
193108.1000	A* RKL4313/010.0	10.0	(4G4+(2×1.0)+(2×1.5))	16.3
193257.1000	A* RKL4314/010.0	10.0	(4G4+(2×1.0)+(2×1.5))	16.3
193109.1000	A* RKL4315/010.0	10.0	(4G4+(2×1.0)+(2×1.5))	16.3
193246.1000	A* RKL4317/010.0	10.0	(4G6+(2×1.0)+(2×1.5))	18.4
193247.1000	A* RKL4318/010.0	10.0	(4G6+(2×1.0)+(2×1.5))	18.4
193276.1000	A* RKL4345/010.0	10.0	(4G2.5+2×(2×1.0))	14.2
193119.1000	A* RKL4346/010.0	10.0	(4G2.5+2×(2×1.0))	14.2
Extension				
193263.1000	A* RKL4311/010.0	10.0	(4G1.5+2×(2×0.75))	12.9
193278.1000	A* RKL4304/010.0	10.0	(4G1.5+2×(2×0.75))	12.9
193616.1000	A* RKL4305/010.0	10.0	(4G1.0+2×(2×0.75))	12.5
193245.1000	A* RKL4312/010.0	10.0	(4G2.5+2×(2×1.0))	14.2
193110.1000	A* RKL4316/010.0	10.0	(4G4+(2×1.0)+(2×1.5))	16.3
193279.1000	A* RKL4319/010.0	10.0	(4G6+(2×1.0)+(2×1.5))	18.4
193120.1000	A* RKL4347/010.0	10.0	(4G2.5+2×(2×1.0))	14.2

Servomotor cables for C-tracks

According to Bosch Rexroth RKL standard



Application

- Motor cable for Bosch Rexroth SERVO drives
- Through full PUR jacket and TPE conductor insulation optimally suited for c-tracks, extremely harsh operating conditions and aggressive coolants and lubricants

Properties

- Silicone free
- RoHS compliant

Construction

Jacket material
Surface
Jacket color

PUR
matte, adhesion-free
orange RAL 2003

Rated voltage U_N
Temperature range fixed
Temperature range moving
Minimum bending radius fixed
Minimum bending radius moving
Burning behavior according to

1000 V 80 °C
-40 °C ... +80 °C
-25 °C ... +80 °C
6×D
10×D
IEC 60332-1
DIN EN 50265-2
VDE 0482 Part 265-2
UL 1581 part 1080 VW-1
UL FT1
EN 50267-2-1

Halogen free according to
Certifications

Note

cURus

* Bosch Rexroth article designations are registered trademarks of Bosch Rexroth, and are for reference purposes only

Technical data

Part No.	BOSCH REXROTH designation*	Cable length m	Number of conductors/cross-section	Outer Ø mm
Base cable				
193094.1000	A* RKL0045/010.0	10.0	(4G1.5+2×(2×0.75))	12.9
193099.1000	A* RKL0051/010.0	10.0	(4G2.5+2×(2×1.0))	14.2
193102.1000	A* RKL4354/010.0	10.0	(4G1.5+2×(2×0.75))	12.9
193103.1000	A* RKL0055/010.0	10.0	(4G6+(2×1.0)+(2×1.5))	18.4
193104.1000	A* RKL0056/010.0	10.0	(4G4+(2×1.0)+(2×1.5))	16.3
193259.1000	A* RKL4320/010.0	10.0	(4G1.5+2×(2×0.75))	12.9
193252.1000	A* RKL4321/010.0	10.0	(4G2.5+2×(2×0.75))	14.2
193282.1000	A* RKL4322/010.0	10.0	(4G4+(2×1.0)+(2×1.5))	16.3
193248.1000	A* RKL4323/010.0	10.0	(4G6+(2×1.0)+(2×1.5))	18.4
193249.1000	A* RKL4324/010.0	10.0	(4G10+(2×1.0)+(2×1.5))	22.3
193272.1000	A* RKL4325/010.0	10.0	(4G1.5+2×(2×0.75))	12.9
193111.1000	A* RKL4326/010.0	10.0	(4G2.5+2×(2×1.0))	14.2
193112.1000	A* RKL4327/010.0	10.0	(4G4+(2×1.0)+(2×1.5))	16.3
193250.1000	A* RKL4328/010.0	10.0	(4G6+(2×1.0)+(2×1.5))	18.4
193251.1000	A* RKL4329/010.0	10.0	(4G10+(2×1.0)+(2×1.5))	22.3
193253.1000	R* RKL4330/010.0	10.0	(4G16+2×(2×1.5))	23.0
193254.1000	R* RKL4331/010.0	10.0	(4G25+2×(2×1.5))	29.3
193113.1000	R* RKL4332/010.0	10.0	(4G35+2×(2×1.5))	32.5
193114.1000	R* RKL4333/010.0	10.0	(4G25+2×(2×1.5))	29.3
193115.1000	R* RKL4334/010.0	10.0	(4G35+2×(2×1.5))	32.5
193260.1000	A* RKL4343/010.0	10.0	(4G2.5+2×(2×0.75))	14.2
193118.1000	A* RKL4344/010.0	10.0	(4G16+2×(2×1.5))	26.8
193121.1000	R* RKL4349/010.0	10.0	(4G16+2×(2×1.5))	26.8
193122.1000	R* RKL4387/010.0	10.0	(4G35+2×(2×1.5))	32.5
193123.1000	R* RKL4778/010.0	10.0	(4G35+2×(2×1.5))	32.5
193124.1000	R* RKL4785/010.0	10.0	(4G25+2×(2×1.5))	29.3
Extension				
193116.1000	A* RKL4335/010.0	10.0	(4G1.5+2×(2×0.75))	12.9
193004.1000	A* RKL4336/010.0	10.0	(4G2.5+2×(2×1.0))	14.2
193255.1000	A* RKL4337/010.0	10.0	(4G4+(2×1.0)+(2×1.5))	16.3
193256.1000	A* RKL4338/010.0	10.0	(4G6+(2×1.0)+(2×1.5))	18.4
193270.1000	A* RKL4339/010.0	10.0	(4G10+(2×1.0)+(2×1.5))	22.3
193271.1000	R* RKL4340/010.0	10.0	(4G16+2×(2×1.5))	26.8
193264.1000	R* RKL4341/010.0	10.0	(4G25+2×(2×1.5))	29.3
193117.1000	R* RKL4342/010.0	10.0	(4G35+2×(2×1.5))	32.5

Signal cables for C-tracks

According to Bosch Rexroth IKS/RKG standard



Application

- Signal cables
- Through full PUR jacket and TPE conductor insulation optimally suited for c-tracks, extremely harsh operating conditions and aggressive coolants and lubricants

Properties

- Silicone free
- RoHS compliant

Construction

Jacket material
Surface
Jacket color

PUR
matte, adhesion-free
orange RAL 2003

Rated voltage U_N
Temperature range fixed
Temperature range moving
Minimum bending radius fixed
Minimum bending radius moving
Burning behavior according to

300 V 80 °C
-40 °C ... +80 °C
-25 °C ... +80 °C
6×D
12×D
IEC 60332-1
DIN EN 50265-2
VDE 0482 Part 265-2
UL 1581 part 1080 VW-1
UL FT1
EN 50267-2-1

Halogen free according to
Certifications

Note

cURus
* Bosch Rexroth article designations are registered trademarks of Bosch Rexroth, and are for reference purposes only

Technical data

Part No.	BOSCH REXROTH designation*	Cable length m	Number of conductors/cross- section	Outer Ø mm
Base cable				
193126.1000	A* RKG0030/010.0	10.0	(2×1.0+4×2×0.25)	8.9
193171.1000	A* RKG0036/010.0	10.0	(4×1.0 + 4×2×0.14 + (4×0.14))	9.5
193034.1000	A* RKG4200/010.0	10.0	(2×0.5+4×2×0.25)	8.7
193088.1000	A* RKG4202/010.0	10.0	(2×0.5+4×2×0.25)	8.7
193146.1000	A* IKS4038/010.0	10.0	(4×1.0 + 4×2×0.14 + (4×0.14))	9.5
Extension				
193001.1000	A* RKG4201/010.0	10.0	(2×0.5+4×2×0.25)	8.7

OCT hybrid cables for C-tracks

According to SIEMENS standard Single-cable Hybrid SERVO motor lines



Application

- Combined power supply cable with motor supply, brake and digital feedback especially for SERVO drives in machine and plant construction, transport and conveyor technology
- Through full PUR jacket and TPE / HGI conductor insulation optimally suited for c-tracks, extremely harsh operating conditions and aggressive coolants and lubricants
- Especially for industrial environments, machines and plants

Properties

- High active and passive interference resistance (EMC)
- Braided shield optimised for continuous flexing use
- Very good alternating bending strength
- Low adhesion, abrasion-resistant, nick-resistant, tear-resistant
- Weathering, ozone and UV resistant (normal lighting conditions)
- industrial- and salt water resistant
- Excellent coolant and lubricant resistance
- Largely resistant to oils, greases, alcohol-free benzines and kerosene
- Halogen free
- Silicone free

- RoHS compliant

Construction

Jacket material
Surface
Jacket color

PUR
matte, adhesion-free
orange RAL 2003

Technical data

Temperature range moving
Minimum bending radius fixed
Minimum bending radius moving
Burning behavior according to

-40 °C ... +80 °C
5×D
7.5×D
DIN EN 60332-1-2
IEC 60332-1-2
UL VW1, FT1
IEC 60754-1

Halogen free according to
Certifications

cURus

* Siemens article designations are registered trademarks of Siemens AG, and are for reference purposes only

Note

Part No.	SIEMENS designation*	Cable length m	Number of conductors/cross- section	Outer Ø mm
Base cable speed-connect				
198535.1000	A* 6FX8002-8QN04-1BA0	10.0	(4GAWG22+(2×AWG22) +(4×AWG26))	9.8
198536.1000	A* 6FX8002-8QN08-1BA0	10.0	(4G0,75+(2×0,5)+(4×0,2))	10.5
198553.1000	A* 6FX8002-8QN11-1BA0	10.0	(4G1,5+(2×1,5)+(4×0,2))	12.7
198554.1000	A* 6FX8002-8QN21-1BA0	10.0	(4G2,5+(2×1,5)+(4×0,2))	13.7

Servo cable assemblies for fixed wiring

According to SIEMENS 6FX5002 standard Base cable



Application

- Base cable for Siemens servo drives
- For flexible applications without compulsory guide
- More cost-effective alternative to the cable chain version 6FX8002

Properties

- PVC Flame-retardant, self-extinguishing
- Silicone free
- RoHS compliant

Construction

Jacket material
Jacket color

PVC
orange RAL 2003

Rated voltage U_N

Temperature range fixed
Temperature range moving
Minimum bending radius fixed
Minimum bending radius moving
Burning behavior according to

1000 V 80 °C
-25 °C ... +80 °C
-5 °C ... +80 °C
6×D
10×D
IEC 60332-1
DIN EN 50265-2
VDE 0482 Part 265-2
UL 1581 part 1080 VW-1
UL FT1

Certifications

Note

cURus
* Siemens article designations are registered trademarks of Siemens AG, and are for reference purposes only

Technical data

Part No.	SIEMENS designation*	Cable length m	Number of conductors/cross- section	Outer Ø mm
SINAMICS, speed-connect / Booksize without brake pairs				
198406.1000	A* 6FX5002-5CN06-1BA0	10.0	(4G1.5)	8.4
198408.1000	A* 6FX5002-5CN26-1BA0	10.0	(4G1.5)	8.4
198411.1000	A* 6FX5002-5CS06-1BA0	10.0	(4G1.5)	8.4
198413.1000	A* 6FX5002-5CS26-1BA0	10.0	(4G1.5)	8.4
198422.1000	A* 6FX5002-5CN16-1BA0	10.0	(4G1.5)	8.4
198423.1000	A* 6FX5002-5CN36-1BA0	10.0	(4G2.5)	10.6
198425.1000	A* 6FX5002-5CS16-1BA0	10.0	(4G2.5)	10.6
198427.1000	A* 6FX5002-5CS36-1BA0	10.0	(4G2.5)	10.6
198438.1000	A* 6FX5002-5CN46-1BA0	10.0	(4G4)	11.5
198441.1000	A* 6FX5002-5CS46-1BA0	10.0	(4G4)	11.5
198447.1000	A* 6FX5002-5CN56-1BA0	10.0	(4G6)	13.2
198449.1000	A* 6FX5002-5CS56-1BA0	10.0	(4G6)	13.2
198456.1000	A* 6FX5002-5CN66-1BA0	10.0	(4G10)	16.5
198458.1000	A* 6FX5002-5CS17-1BA0	10.0	(4G10)	16.5
198463.1000	A* 6FX5002-5CS66-1BA0	10.0	(4G10)	16.5
SINAMICS, speed-connect / ooksize with brake pairs				
198407.1000	A* 6FX5002-5DN06-1BA0	10.0	(4G1.5+(2×1.5))	11.6
198415.1000	A* 6FX5002-5DN26-1BA0	10.0	(4G1.5+(2×1.5))	11.6
198417.1000	A* 6FX5002-5DS06-1BA0	10.0	(4G1.5+(2×1.5))	11.6
198419.1000	A* 6FX5002-5DS26-1BA0	10.0	(4G1.5+(2×1.5))	11.6
198429.1000	A* 6FX5002-5DN16-1BA0	10.0	(4G2.5+(2×1.5))	13.0
198432.1000	A* 6FX5002-5DN36-1BA0	10.0	(4G2.5+(2×1.5))	13.0
198434.1000	A* 6FX5002-5DS16-1BA0	10.0	(4G2.5+(2×1.5))	13.0
198436.1000	A* 6FX5002-5DS36-1BA0	10.0	(4G2.5+(2×1.5))	13.0
198443.1000	A* 6FX5002-5DN46-1BA0	10.0	(4G4+(2×1.5))	14.0
198445.1000	A* 6FX5002-5DS46-1BA0	10.0	(4G4+(2×1.5))	14.0
198452.1000	A* 6FX5002-5DN56-1BA0	10.0	(4G6+(2×1.5))	15.8
198454.1000	A* 6FX5002-5DS56-1BA0	10.0	(4G6+(2×1.5))	15.8
198465.1000	A* 6FX5002-5DN66-1BA0	10.0	(4G10+(2×1.5))	18.5
198467.1000	A* 6FX5002-5DS66-1BA0	10.0	(4G10+(2×1.5))	18.5
198469.1000	A* 6FX5002-5DS17-1BA0	10.0	(4G10+(2×1.5))	18.5

Servo cable assemblies without brake pairs for fixed installation

According to SIEMENS 6FX5002 standard Base cable



Application

- Base cable for Siemens servo drives
- For flexible applications without compulsory guide
- More cost-effective alternative to the cable chain version 6FX8002

Properties

- PVC Flame-retardant, self-extinguishing
- Silicone free
- RoHS compliant

Construction

Jacket material
Jacket color

PVC
orange RAL 2003

Rated voltage U_N
Temperature range fixed
Temperature range moving
Minimum bending radius fixed
Minimum bending radius moving
Burning behavior according to

1000 V 80 °C
-25 °C ... +80 °C
-5 °C ... +80 °C
6xD
10xD
VDE 0482 Part 265-2
DIN EN 50265-2
IEC 60332-1
UL 1581 part 1080 VW-1
UL FT1

Certifications

Note

cURus

* Siemens article designations are registered trademarks of Siemens AG, and are for reference purposes only

Technical data

Part No.	SIEMENS designation*	Cable length m	Number of conductors/cross- section	Outer Ø mm
SINAMICS, speed-connect/Booksize				
198098.1000	A* 6FX5002-5CN01-1BA0	10.0	(4G1.5)	8.4
198103.1000	A* 6FX5002-5CN11-1BA0	10.0	(4G2.5)	10.6
198104.1000	A* 6FX5002-5CN21-1BA0	10.0	(4G1.5)	8.4
198106.1000	A* 6FX5002-5CN31-1BA0	10.0	(4G2.5)	10.6
198107.1000	A* 6FX5002-5CN41-1BA0	10.0	(4G4)	11.5
198108.1000	A* 6FX5002-5CN51-1BA0	10.0	(4G6)	13.2
198109.1000	A* 6FX5002-5CN61-1BA0	10.0	(4G10)	16.5
SINAMICS, full thread/Booksize				
198205.1000	A* 6FX5002-5CS01-1BA0	10.0	(4G1.5)	8.4
198124.1000	A* 6FX5002-5CS11-1BA0	10.0	(4G2.5)	10.6
198128.1000	A* 6FX5002-5CS13-1BA0	10.0	(4G10)	16.5
198129.1000	A* 6FX5002-5CS21-1BA0	10.0	(4G1.5)	8.4
198132.1000	A* 6FX5002-5CS31-1BA0	10.0	(4G2.5)	10.6
198133.1000	A* 6FX5002-5CS41-1BA0	10.0	(4G4)	11.5
198136.1000	A* 6FX5002-5CS51-1BA0	10.0	(4G6)	13.2
198139.1000	A* 6FX5002-5CS61-1BA0	10.0	(4G10)	16.5
SINAMICS, open end/Booksize				
198123.1000	A* 6FX5002-5CS02-1BA0	10.0	(4G1.5)	8.4
198126.1000	A* 6FX5002-5CS12-1BA0	10.0	(4G2.5)	10.6
198321.1000	A* 6FX5002-5CS42-1BA0	10.0	(4G4)	16.5
198322.1000	A* 6FX5002-5CS52-1BA0	10.0	(4G6)	14.0
198323.1000	A* 6FX5002-5CS62-1BA0	10.0	(4G10)	16.5

Servo cable assemblies without brake pairs for fixed installation

According to SIEMENS 6FX5002 standard Base cable



Application

- Base cable for Siemens servo drives
- For flexible applications without compulsory guide
- More cost-effective alternative to the cable chain version 6FX8002

Properties

- PVC Flame-retardant, self-extinguishing
- Silicone free
- RoHS compliant

Construction

Jacket material
Jacket color

PVC
orange RAL 2003

Rated voltage U_N
Temperature range fixed
Temperature range moving
Minimum bending radius fixed
Minimum bending radius moving
Burning behavior according to

1000 V 80 °C
-25 °C ... +80 °C
-5 °C ... +80 °C
6×D
10×D
IEC 60332-1
DIN EN 50265-2
VDE 0482 Part 265-2
UL 1581 part 1080 VW-1
UL FT1

Certifications

Note

cURus
* Siemens article designations are registered trademarks of Siemens AG, and are for reference purposes only

Technical data

Part No.	SIEMENS designation*	Cable length m	Number of conductors/cross- section	Outer Ø mm
SIMODRIVE, full thread/open end				
198042.1000	A* 6FX5002-5CA01-1BA0	10.0	(4G1.5)	8.4
198046.1000	A* 6FX5002-5CA11-1BA0	10.0	(4G2.5)	10.6
198048.1000	A* 6FX5002-5CA13-1BA0	10.0	(4G10)	16.5
198051.1000	A* 6FX5002-5CA21-1BA0	10.0	(4G1.5)	8.4
198052.1000	A* 6FX5002-5CA23-1BA0	10.0	(4G16)	21.2
198054.1000	A* 6FX5002-5CA31-1BA0	10.0	(4G2.5)	10.6
198059.1000	A* 6FX5002-5CA41-1BA0	10.0	(4G4)	11.5
198063.1000	A* 6FX5002-5CA51-1BA0	10.0	(4G6)	13.2
198066.1000	A* 6FX5002-5CA61-1BA0	10.0	(4G10)	16.5
SINAMICS, full thread/open end				
198068.1000	A* 6FX5002-5CG01-1BA0	10.0	(4G1.5)	8.4
198071.1000	A* 6FX5002-5CG11-1BA0	10.0	(4G2.5)	10.6
198292.1000	A* 6FX5002-5CG13-1BA0	10.0	(4G10)	16.5
198073.1000	A* 6FX5002-5CG21-1BA0	10.0	(4G1.5)	8.4
198293.1000	A* 6FX5002-5CG23-1BA0	10.0	(4G16)	21.2
198078.1000	A* 6FX5002-5CG31-1BA0	10.0	(4G2.5)	10.6
198083.1000	A* 6FX5002-5CG41-1BA0	10.0	(4G4)	11.5
198088.1000	A* 6FX5002-5CG51-1BA0	10.0	(4G6)	14.0
198093.1000	A* 6FX5002-5CG61-1BA0	10.0	(4G10)	16.5
198273.1000	A* 6FX5002-5CS14-1BA0	10.0	(4G10)	16.5
198294.1000	A* 6FX5002-5CS23-1BA0	10.0	(4G16)	21.2
198299.1000	A* 6FX5002-5CS54-1BA0	10.0	(4G6)	14.0
198309.1000	A* 6FX5002-5CS64-1BA0	10.0	(4G10)	16.5
198353.1000	A* 6FX5002-5CG32-1BA0	10.0	(4G2.5)	10.6

Servo cable assemblies with brake pairs for fixed installation

According to SIEMENS 6FX5002 standard Base cable



Application

- Base cable for Siemens servo drives
- For flexible applications without compulsory guide
- More cost-effective alternative to the cable chain version 6FX8002

Properties

- PVC Flame-retardant, self-extinguishing
- Silicone free
- RoHS compliant

Construction

Jacket material PVC
Jacket color orange RAL 2003

Rated voltage U_N 1000 V 80 °C
Temperature range fixed -25 °C ... +80 °C
Temperature range moving -5 °C ... +80 °C
Minimum bending radius fixed 6xD
Minimum bending radius moving 10xD
Burning behavior according to VDE 0482 Part 265-2
DIN EN 50265-2
IEC 60332-1
UL 1581 part 1080 VW-1
UL FT1

Certifications

Note

cURus
* Siemens article designations are registered trademarks of Siemens AG, and are for reference purposes only

Technical data

Part No.	SIEMENS designation*	Cable length m	Number of conductors/cross-section	Outer Ø mm
SINAMICS, speed-connect/Booksize				
198340.1000	A* 6FX5002-5DN01-1BA0	10.0	(4G1.5+(2×1.5))	11.6
198341.1000	A* 6FX5002-5DN11-1BA0	10.0	(4G2.5+(2×1.5))	13.0
198342.1000	A* 6FX5002-5DN21-1BA0	10.0	(4G1.5+(2×1.5))	11.6
198343.1000	A* 6FX5002-5DN31-1BA0	10.0	(4G2.5+(2×1.5))	13.0
198344.1000	A* 6FX5002-5DN41-1BA0	10.0	(4G4+(2×1.5))	14.0
198345.1000	A* 6FX5002-5DN51-1BA0	10.0	(4G6+(2×1.5))	15.8
198346.1000	A* 6FX5002-5DN61-1BA0	10.0	(4G10+(2×1.5))	18.5
SINAMICS, full thread/Booksize				
198320.1000	A* 6FX5002-5DS01-1BA0	10.0	(4G1.5+(2×1.5))	11.6
198325.1000	A* 6FX5002-5DS11-1BA0	10.0	(4G2.5+(2×1.5))	13.0
198176.1000	A* 6FX5002-5DS13-1BA0	10.0	(4G10+(2×1.5))	18.5
198177.1000	A* 6FX5002-5DS21-1BA0	10.0	(4G1.5+(2×1.5))	11.6
198245.1000	A* 6FX5002-5DS31-1BA0	10.0	(4G2.5+(2×1.5))	13.0
198178.1000	A* 6FX5002-5DS41-1BA0	10.0	(4G4+(2×1.5))	14.0
198179.1000	A* 6FX5002-5DS51-1BA0	10.0	(4G6+(2×1.5))	15.8
198182.1000	A* 6FX5002-5DS61-1BA0	10.0	(4G10+(2×1.5))	18.5

Servo cable assemblies with brake pairs for fixed installation

According to SIEMENS 6FX5002 standard Base cable



Application

- Base cable for Siemens servo drives
- For flexible applications without compulsory guide
- More cost-effective alternative to the cable chain version 6FX8002

Properties

- PVC Flame-retardant, self-extinguishing
- Silicone free
- RoHS compliant

Construction

Jacket material
Jacket color

PVC
orange RAL 2003

Rated voltage U_N
Temperature range fixed
Temperature range moving
Minimum bending radius fixed
Minimum bending radius moving
Burning behavior according to

1000 V 80 °C
-25 °C ... +80 °C
-5 °C ... +80 °C
6×D
10×D
IEC 60332-1
DIN EN 50265-2
VDE 0482 Part 265-2
UL 1581 part 1080 VW-1
UL FT1

Certifications

Note

cURus
* Siemens article designations are registered trademarks of Siemens AG, and are for reference purposes only

Technical data

Part No.	SIEMENS designation*	Cable length m	Number of conductors/cross-section	Outer Ø mm
SIMODRIVE, full thread/open end				
198461.1000	A* 6FX5002-5DA01-1BA0	10.0	(4G1.5+(2×1.5))	11.6
198481.1000	A* 6FX5002-5DA11-1BA0	10.0	(4G2.5+(2×1.5))	13.0
198146.1000	A* 6FX5002-5DA13-1BA0	10.0	(4G10+(2×1.5))	18.5
198501.1000	A* 6FX5002-5DA21-1BA0	10.0	(4G1.5+(2×1.5))	11.6
198871.1000	A* 6FX5002-5DA23-1BA0	10.0	(4G16+(2×1.5))	23.6
198531.1000	A* 6FX5002-5DA31-1BA0	10.0	(4G2.5+(2×1.5))	13.0
198881.1000	A* 6FX5002-5DA33-1BA0	10.0	(4G25+(2×1.5))	28.5
198561.1000	A* 6FX5002-5DA41-1BA0	10.0	(4G4+(2×1.5))	14.0
198571.1000	A* 6FX5002-5DA51-1BA0	10.0	(4G6+(2×1.5))	15.8
198581.1000	A* 6FX5002-5DA61-1BA0	10.0	(4G10+(2×1.5))	18.5
SINAMICS, full thread/open end				
198076.1000	A* 6FX5002-5DG01-1BA0	10.0	(4G1.5+(2×1.5))	11.6
198086.1000	A* 6FX5002-5DG11-1BA0	10.0	(4G2.5+(2×1.5))	13.0
198287.1000	A* 6FX5002-5DG13-1BA0	10.0	(4G10+(2×1.5))	18.5
198081.1000	A* 6FX5002-5DG21-1BA0	10.0	(4G1.5+(2×1.5))	11.6
198288.1000	A* 6FX5002-5DG23-1BA0	10.0	(4G16+(2×1.5))	23.6
198091.1000	A* 6FX5002-5DG31-1BA0	10.0	(4G2.5+(2×1.5))	13.0
198289.1000	A* 6FX5002-5DG33-1BA0	10.0	(4G25+(2×1.5))	28.6
198096.1000	A* 6FX5002-5DG41-1BA0	10.0	(4G4+(2×1.5))	14.0
198101.1000	A* 6FX5002-5DG51-1BA0	10.0	(4G6+(2×1.5))	15.8
198116.1000	A* 6FX5002-5DG61-1BA0	10.0	(4G10+(2×1.5))	18.5
198296.1000	A* 6FX5002-5DS14-1BA0	10.0	(4G10+(2×1.5))	18.5
198264.1000	A* 6FX5002-5DS23-1BA0	10.0	(4G16+(2×1.5))	23.6
198297.1000	A* 6FX5002-5DS54-1BA0	10.0	(4G6+(2×1.5))	15.8
198298.1000	A* 6FX5002-5DS64-1BA0	10.0	(4G10+(2×1.5))	18.5

Servo cable assemblies without brake pairs for fixed installation

According to SIEMENS 6FX5002 standard
Extension



Application

- Base cable for Siemens servo drives
- For flexible applications without compulsory guide
- More cost-effective alternative to the cable chain version 6FX8002

Properties

- PVC Flame-retardant, self-extinguishing
- Silicone free
- RoHS compliant

Construction

Jacket material PVC
Jacket color orange RAL 2003

Rated voltage U_N 1000 V 80 °C
Temperature range fixed -25 °C ... +80 °C
Temperature range moving -5 °C ... +80 °C
Minimum bending radius fixed 6×D
Minimum bending radius moving 10×D
Burning behavior according to IEC 60332-1
DIN EN 50265-2
VDE 0482 Part 265-2
UL 1581 part 1080 VW-1
UL FT1

Certifications

Note

cURus
* Siemens article designations are registered trademarks of Siemens AG, and are for reference purposes only

Technical data

Part No.	SIEMENS designation*	Cable length m	Number of conductors/cross- section	Outer Ø mm
SINAMICS/SIMODRIVE, full thread				
198044.1000	A* 6FX5002-5CA05-1BA0	10.0	(4G1.5)	8.4
198049.1000	A* 6FX5002-5CA15-1BA0	10.0	(4G2.5)	10.6
198053.1000	A* 6FX5002-5CA28-1BA0	10.0	(4G1.5)	8.4
198058.1000	A* 6FX5002-5CA38-1BA0	10.0	(4G2.5)	10.6
198062.1000	A* 6FX5002-5CA48-1BA0	10.0	(4G4)	11.5
198064.1000	A* 6FX5002-5CA58-1BA0	10.0	(4G6)	13.2
198067.1000	A* 6FX5002-5CA68-1BA0	10.0	(4G10)	16.5

Servo cable assemblies with brake pairs for fixed installation

According to SIEMENS 6FX5002 standard Extension



Application

- Base cable for Siemens servo drives
- For flexible applications without compulsory guide
- More cost-effective alternative to the cable chain version 6FX8002

Properties

- PVC Flame-retardant, self-extinguishing
- Silicone free
- RoHS compliant

Construction

Jacket material PVC
Jacket color orange RAL 2003

Rated voltage U_N 1000 V 80 °C
Temperature range fixed -25 °C ... +80 °C
Temperature range moving -5 °C ... +80 °C
Minimum bending radius fixed 6×D
Minimum bending radius moving 10×D
Burning behavior according to IEC 60332-1
DIN EN 50265-2
VDE 0482 Part 265-2
UL 1581 part 1080 VW-1
UL FT1

Certifications

Note

cURus
* Siemens article designations are registered trademarks of Siemens AG, and are for reference purposes only

Technical data

Part No.	SIEMENS designation*	Cable length m	Number of conductors/cross-section	Outer Ø mm
SINAMICS/SIMODRIVE, full thread				
198731.1000	A* 6FX5002-5DA05-1BA0	10.0	(4G1.5+(2×1.5))	11.6
198991.1000	A* 6FX5002-5DA15-1BA0	10.0	(4G2.5+(2×1.5))	13.0
198791.1000	A* 6FX5002-5DA28-1BA0	10.0	(4G1.5+(2×1.5))	11.6
198801.1000	A* 6FX5002-5DA38-1BA0	10.0	(4G2.5+(2×1.5))	13.0
198006.1000	A* 6FX5002-5DA48-1BA0	10.0	(4G4+(2×1.5))	14.0
198011.1000	A* 6FX5002-5DA58-1BA0	10.0	(4G6+(2×1.5))	15.8
198026.1000	A* 6FX5002-5DA68-1BA0	10.0	(4G10+(2×1.5))	18.5
198184.1000	A* 6FX5002-5DX28-1BA0	10.0	(4G16+(2×1.5))	23.6
198186.1000	A* 6FX5002-5DX38-1BA0	10.0	(4G25+(2×1.5))	28.5

Signal cable for fixed wiring

According to SIEMENS 6FX5002 standard Base cable DRIVE-CLIQ



Application

- Signal cable for SIEMENS SERVO drives
- For flexible applications without compulsory guide
- More cost-effective alternative to the cable chain version 6FX8002

Properties

- PVC Flame-retardant, self-extinguishing
- Silicone free
- RoHS compliant

Construction

Jacket material
Surface
Jacket color

Special PVC
matte, adhesion-free
green RAL 6018

Technical data

Rated voltage U_N

30 V 80 °C

Temperature range fixed
Temperature range moving
Minimum bending radius fixed
Minimum bending radius moving
Burning behavior according to

-25 °C ... +80 °C
-5 °C ... +80 °C
7.5xD
15xD
IEC 60332-1
DIN EN 50265-2
VDE 0482 Part 265-2
UL VW-1
UL FT1

Certifications

Note

Note

cURus

Permitted total cable length ≤ 100 m
(6FX5...) or ≤ 75 m (6FX8...)

* Siemens article designations are registered trademarks of Siemens AG, and are for reference purposes only

Part No.	SIEMENS designation*	Cable length m	Number of conductors/cross- section	Outer Ø mm
SINAMICS				
198475.1000	A* 6FX5002-2DC40-1BA0	10.0	(2×2×AWG26+1×2×AWG22)	7.2
198477.1000	A* 6FX5002-2DC42-1BA0	10.0	(2×2×AWG26+1×2×AWG22)	7.2
198479.1000	A* 6FX5002-2DC44-1BA0	10.0	(2×2×AWG26+1×2×AWG22)	7.2
198484.1000	A* 6FX5002-2DD40-1BA0	10.0	(2×2×AWG26+1×2×AWG22)	7.2
198486.1000	A* 6FX5002-2DD42-1BA0	10.0	(2×2×AWG26+1×2×AWG22)	7.2
198488.1000	A* 6FX5002-2DD44-1BA0	10.0	(2×2×AWG26+1×2×AWG22)	7.2
198499.1000	A* 6FX5002-2DC48-1BA0	10.0	(2×2×AWG26+1×2×AWG22)	7.2
198504.1000	A* 6FX5002-2DD48-1BA0	10.0	(2×2×AWG26+1×2×AWG22)	7.2

Signal cable for fixed wiring

According to SIEMENS 6FX5002 Base cable DRIVE-CLIQ



Application

- Signal cable for SIEMENS SERVO drives
- Through full PUR jacket and TPE conductor insulation optimally suited for c-tracks, extremely harsh operating conditions and aggressive coolants and lubricants
- Especially for industrial environments, machines and plants

Properties

- PVC Flame-retardant, self-extinguishing
- Silicone free
- RoHS compliant

Construction

Jacket material	Special PVC
Surface	matte, adhesion-free
Jacket color	green RAL 6018

Technical data

Rated voltage U_N	30 V 80 °C
Temperature range fixed	-25 °C ... +80 °C
Temperature range moving	-5 °C ... +80 °C
Minimum bending radius fixed	7.5×D
Minimum bending radius moving	15×D
Burning behavior according to	IEC 60332-1 DIN EN 50265-2 VDE 0482 Part 265-2 UL VW-1 UL FT1

Certifications

Note

Note

cURus
The total length of the DRIVE-CLIQ train does not exceed more than 30 m.
* Siemens article designations are registered trademarks of Siemens AG, and are for reference purposes only

Part No.	SIEMENS designation*	Cable length m	Number of conductors/cross- section	Outer Ø mm
SINAMICS				
198493.1000	A* 6FX5002-2DC46-1BA0	10.0	(2×2×AWG26+1×2×AWG22)	7.2
198495.1000	A* 6FX5002-2DC30-1BA0	10.0	(2×2×AWG26+1×2×AWG22)	7.2
198506.1000	A* 6FX5002-2DC36-1BA0	10.0	(2×2×AWG26+1×2×AWG22)	7.2

Signal cable assemblies for fixed installation

According to SIEMENS 6FX5002 standard
Base cable DRIVE-CLIQ



Application

- Resolver cable
- For flexible applications without compulsory guide
- More cost-effective alternative to the cable chain version 6FX8002

Properties

- Silicone free
- RoHS compliant

Construction

Jacket material
Jacket color

PVC
green RAL 6018

Rated voltage U_N

Temperature range fixed
Temperature range moving
Minimum bending radius fixed
Minimum bending radius moving
Burning behavior according to

30 V 80 °C

-25 °C ... +80 °C
-5 °C ... +80 °C

7.5xD
15xD

IEC 60332-1
DIN EN 50265-2
VDE 0482 Part 265-2

Certifications

Note

cURus

* Siemens article designations are registered trademarks of Siemens AG, and are for reference purposes only

Technical data

Part No.	SIEMENS designation*	Cable length m	Number of conductors/cross- section	Outer Ø mm
SINAMICS				
198036.1000	A* 6FX5002-2DC00-1BA0	10.0	(2×2×0.15+1×2×0.38)	7.2
198037.1000	A* 6FX5002-2DC10-1BA0	10.0	(2×2×0.15+1×2×0.38)	7.2
198038.1000	A* 6FX5002-2DC20-1BA0	10.0	(2×2×0.15+1×2×0.38)	7.2

Servo cable assemblies for C-tracks

According to SIEMENS 6FX8002 standard Base cable



Application

- Base cable for Siemens servo drives
- Through full PUR jacket and TPE conductor insulation optimally suited for c-tracks, extremely harsh operating conditions and aggressive coolants and lubricants
- Especially for industrial environments, machines and plants

Properties

- Very good alternating bending strength
- Hydrolysis-resistant, microbe-resistant, and rot-resistant
- Weathering, ozone and UV resistant (normal lighting conditions)
- Industrial and salt water resistant
- Largely resistant to oils, greases, alcohol-free benzines and kerosene
- Silicone free
- RoHS compliant

Construction

Jacket material
Surface

Special PUR
matte, adhesion-free

Jacket color

orange RAL 2003

Technical data

Rated voltage U_N 1000 V 80 °C
 Temperature range fixed -40 °C ... +80 °C
 Temperature range moving -25 °C ... +80 °C
 Minimum bending radius fixed 6xD
 Minimum bending radius moving 10xD
 Burning behavior according to IEC 60332-1
 DIN EN 50265-2
 VDE 0482 Part 265-2
 UL 1581 part 1080 VW-1
 UL FT1
 EN 50267-2-1

Halogen free according to
Certifications

Note

cURus
* Siemens article designations are registered trademarks of Siemens AG, and are for reference purposes only

Part No.	SIEMENS designation*	Cable length m	Number of conductors/ cross-section	Outer Ø mm	Conductor
SINAMICS, speed-connect / Booksize without brake pairs					
198398.1000	A* 6FX8002-5CN06-1BA0	10.0	(4G1.5)	8.4	CU-wire bare
198409.1000	A* 6FX8002-5CN26-1BA0	10.0	(4G1.5)	8.4	CU-wire bare
198412.1000	A* 6FX8002-5CS06-1BA0	10.0	(4G1.5)	8.4	CU-wire bare
198414.1000	A* 6FX8002-5CS26-1BA0	10.0	(4G1.5)	8.4	CU-wire bare
198399.1000	A* 6FX8002-5CN16-1BA0	10.0	(4G2.5)	10.6	CU-wire bare
198424.1000	A* 6FX8002-5CN36-1BA0	10.0	(4G2.5)	10.6	CU-wire bare
198426.1000	A* 6FX8002-5CS16-1BA0	10.0	(4G2.5)	10.6	CU-wire bare
198428.1000	A* 6FX8002-5CS36-1BA0	10.0	(4G2.5)	10.6	CU-wire bare
198439.1000	A* 6FX8002-5CN46-1BA0	10.0	(4G4)	12.2	CU-wire bare
198442.1000	A* 6FX8002-5CS46-1BA0	10.0	(4G4)	12.2	CU-wire bare
198448.1000	A* 6FX8002-5CN56-1BA0	10.0	(4G6)	14.0	CU-wire bare
198451.1000	A* 6FX8002-5CS56-1BA0	10.0	(4G6)	14.0	CU-wire bare
198401.1000	A* 6FX8002-5CN56-1BA0	10.0	(4G6)	13.2	CU-wire bare
198457.1000	A* 6FX8002-5CN66-1BA0	10.0	(4G10)	17.6	CU-wire bare
198459.1000	A* 6FX8002-5CS17-1BA0	10.0	(4G10)	17.6	CU-wire bare
198464.1000	A* 6FX8002-5CS66-1BA0	10.0	(4G10)	17.6	CU-wire bare
SINAMICS, speed-connect / Booksize with brake pairs					
198403.1000	A* 6FX8002-5DN06-1BA0	10.0	(4G1.5+(2x1.5))	11.4	CU-wire bare
198416.1000	A* 6FX8002-5DN26-1BA0	10.0	(4G1.5+(2x1.5))	11.4	CU-wire bare
198418.1000	A* 6FX8002-5DS06-1BA0	10.0	(4G1.5+(2x1.5))	11.4	CU-wire bare
198421.1000	A* 6FX8002-5DS26-1BA0	10.0	(4G1.5+(2x1.5))	11.4	CU-wire bare
198431.1000	A* 6FX8002-5DN16-1BA0	10.0	(4G2.5+(2x1.5))	12.9	CU-wire bare
198433.1000	A* 6FX8002-5DN36-1BA0	10.0	(4G2.5+(2x1.5))	12.9	CU-wire bare
198435.1000	A* 6FX8002-5DS16-1BA0	10.0	(4G2.5+(2x1.5))	12.9	CU-wire bare
198437.1000	A* 6FX8002-5DS36-1BA0	10.0	(4G2.5+(2x1.5))	12.9	CU-wire bare
198444.1000	A* 6FX8002-5DN46-1BA0	10.0	(4G4+(2x1.5))	14.5	CU-wire bare
198446.1000	A* 6FX8002-5DS46-1BA0	10.0	(4G4+(2x1.5))	14.5	CU-wire bare
198453.1000	A* 6FX8002-5DN56-1BA0	10.0	(4G6+(2x1.5))	16.1	CU-wire bare
198455.1000	A* 6FX8002-5DS56-1BA0	10.0	(4G6+(2x1.5))	16.1	CU-wire bare
198466.1000	A* 6FX8002-5DN66-1BA0	10.0	(4G10+(2x1.5))	19.5	CU-wire bare
198468.1000	A* 6FX8002-5DS66-1BA0	10.0	(4G10+(2x1.5))	19.5	CU-wire bare
198473.1000	A* 6FX8002-5DS17-1BA0	10.0	(4G10+(2x1.5))	19.5	CU-wire bare

Servo cable assemblies without brake pairs for C-tracks

According to SIEMENS 6FX8002 standard Base cable



Application

- Base cable for Siemens servo drives
- Through full PUR jacket and TPE conductor insulation optimally suited for c-tracks, extremely harsh operating conditions and aggressive coolants and lubricants
- Especially for industrial environments, machines and plants

Properties

- Silicone free
- RoHS compliant

Construction

Jacket material PUR
Surface matte, adhesion-free
Jacket color orange RAL 2003

Rated voltage U_N 1000 V 80 °C
Temperature range fixed -40 °C ... +80 °C
Temperature range moving -25 °C ... +80 °C
Minimum bending radius fixed 6×D
Minimum bending radius moving 10×D
Burning behavior according to IEC 60332-1
DIN EN 50265-2
VDE 0482 Part 265-2
UL 1581 part 1080 VW-1
UL FT1
EN 50267-2-1

Halogen free according to Certifications

Note

cURus
* Siemens article designations are registered trademarks of Siemens AG, and are for reference purposes only

Technical data

Part No.	SIEMENS designation*	Cable length m	Number of conductors/cross-section	Outer Ø mm
SINAMICS, speed-connect/Booksize				
198326.1000	A* 6FX8002-5CN01-1BA0	10.0	(4G1.5)	8.6
198327.1000	A* 6FX8002-5CN11-1BA0	10.0	(4G2.5)	10.8
198328.1000	A* 6FX8002-5CN21-1BA0	10.0	(4G1.5)	8.6
198329.1000	A* 6FX8002-5CN31-1BA0	10.0	(4G2.5)	10.8
198330.1000	A* 6FX8002-5CN41-1BA0	10.0	(4G4)	12.2
198331.1000	A* 6FX8002-5CN51-1BA0	10.0	(4G6)	14.0
198332.1000	A* 6FX8002-5CN61-1BA0	10.0	(4G10)	17.6
SINAMICS, full thread/Booksize				
198300.1000	A* 6FX8002-5CS01-1BA0	10.0	(4G1.5)	8.6
198302.1000	A* 6FX8002-5CS11-1BA0	10.0	(4G2.5)	10.8
198214.1000	A* 6FX8002-5CS13-1BA0	10.0	(4G10)	17.6
198304.1000	A* 6FX8002-5CS21-1BA0	10.0	(4G1.5)	8.6
198305.1000	A* 6FX8002-5CS31-1BA0	10.0	(4G2.5)	10.8
198317.1000	A* 6FX8002-5CS41-1BA0	10.0	(4G4)	12.2
198318.1000	A* 6FX8002-5CS51-1BA0	10.0	(4G6)	14.0
198319.1000	A* 6FX8002-5CS61-1BA0	10.0	(4G10)	17.6
SINAMICS, open end/Booksize				
198303.1000	A* 6FX8002-5CS12-1BA0	10.0	(4G2.5)	10.6
198306.1000	A* 6FX8002-5CS42-1BA0	10.0	(4G4)	12.2

Servo cable assemblies without brake pairs for C-tracks

According to SIEMENS 6FX8002 standard Base cable



Application

- Base cable for Siemens servo drives
- Through full PUR jacket and TPE conductor insulation optimally suited for c-tracks, extremely harsh operating conditions and aggressive coolants and lubricants

Properties

- Silicone free
- RoHS compliant

Construction

Jacket material
Surface
Jacket color

PUR
matte, adhesion-free
orange RAL 2003

Rated voltage U_N
Temperature range fixed
Temperature range moving
Minimum bending radius fixed
Minimum bending radius moving
Burning behavior according to

1000 V 80 °C
-40 °C ... +80 °C
-25 °C ... +80 °C
6×D
10×D
IEC 60332-1
DIN EN 50265-2
VDE 0482 Part 265-2
UL 1581 part 1080 VW-1
UL FT1
EN 50267-2-1

Halogen free according to
Certifications

Note

cURus
* Siemens article designations are registered trademarks of Siemens AG, and are for reference purposes only

Technical data

Part No.	SIEMENS designation*	Cable length m	Number of conductors/cross- section	Outer Ø mm
SIMODRIVE, full thread/open end				
198360.1000	A* 6FX8002-5CA01-1BA0	10.0	(4G1.5)	8.6
198380.1000	A* 6FX8002-5CA11-1BA0	10.0	(4G2.5)	10.8
198845.1000	A* 6FX8002-5CA13-1BA0	10.0	(4G10)	17.6
198400.1000	A* 6FX8002-5CA21-1BA0	10.0	(4G1.5)	8.6
198810.1000	A* 6FX8002-5CA23-1BA0	10.0	(4G16)	21.2
198410.1000	A* 6FX8002-5CA31-1BA0	10.0	(4G2.5)	10.8
198430.1000	A* 6FX8002-5CA41-1BA0	10.0	(4G4)	12.2
198440.1000	A* 6FX8002-5CA51-1BA0	10.0	(4G6)	14.0
198450.1000	A* 6FX8002-5CA61-1BA0	10.0	(4G10)	17.6
SINAMICS, full thread/open end				
198950.1000	A* 6FX8002-5CG01-1BA0	10.0	(4G1.5)	8.6
198040.1000	A* 6FX8002-5CG11-1BA0	10.0	(4G2.5)	10.8
198283.1000	A* 6FX8002-5CG13-1BA0	10.0	(4G10)	17.6
198035.1000	A* 6FX8002-5CG21-1BA0	10.0	(4G1.5)	8.6
198803.1000	A* 6FX8002-5CG23-1BA0	10.0	(4G16)	21.2
198045.1000	A* 6FX8002-5CG31-1BA0	10.0	(4G2.5)	10.8
198198.1000	A* 6FX8002-5CG32-1BA0	10.0	(4G2.5)	10.8
198050.1000	A* 6FX8002-5CG41-1BA0	10.0	(4G4)	12.2
198055.1000	A* 6FX8002-5CG51-1BA0	10.0	(4G6)	14.0
198060.1000	A* 6FX8002-5CG61-1BA0	10.0	(4G10)	17.6
198284.1000	A* 6FX8002-5CS14-1BA0	10.0	(4G10)	17.6
198285.1000	A* 6FX8002-5CS23-1BA0	10.0	(4G16)	21.2
198980.1000	A* 6FX8002-5CS54-1BA0	10.0	(4G6)	14.0
198286.1000	A* 6FX8002-5CS64-1BA0	10.0	(4G10)	17.6

Servo cable assemblies with brake pairs for C-tracks

According to SIEMENS 6FX8002 standard Base cable



Application

- Base cable for Siemens servo drives
- Through full PUR jacket and TPE conductor insulation optimally suited for c-tracks, extremely harsh operating conditions and aggressive coolants and lubricants
- Especially for industrial environments, machines and plants

Properties

- Silicone free
- RoHS compliant

Construction

Jacket material	PUR
Surface	matte, adhesion-free
Jacket color	orange RAL 2003

Technical data

Rated voltage U_N 1000 V 80 °C
 Temperature range fixed -40 °C ... +80 °C
 Temperature range moving -25 °C ... +80 °C
 Minimum bending radius fixed 6×D
 Minimum bending radius moving 10×D
 Burning behavior according to IEC 60332-1
 DIN EN 50265-2
 VDE 0482 Part 265-2
 UL 1581 part 1080 VW-1
 UL FT1
 EN 50267-2-1

Halogen free according to Certifications

Note

1000 V 80 °C
 -40 °C ... +80 °C
 -25 °C ... +80 °C
 6×D
 10×D
 IEC 60332-1
 DIN EN 50265-2
 VDE 0482 Part 265-2
 UL 1581 part 1080 VW-1
 UL FT1
 EN 50267-2-1

cURus

* Siemens article designations are registered trademarks of Siemens AG, and are for reference purposes only

Part No.	SIEMENS designation*	Cable length m	Number of conductors/cross-section	Outer Ø mm
SINAMICS, speed-connect/Booksize				
198333.1000	A* 6FX8002-5DN01-1BA0	10.0	(4G1.5+(2×1.5))	11.4
198334.1000	A* 6FX8002-5DN11-1BA0	10.0	(4G2.5+(2×1.5))	12.9
198335.1000	A* 6FX8002-5DN21-1BA0	10.0	(4G1.5+(2×1.5))	11.4
198336.1000	A* 6FX8002-5DN31-1BA0	10.0	(4G2.5+(2×1.5))	12.9
198337.1000	A* 6FX8002-5DN41-1BA0	10.0	(4G4+(2×1.5))	14.5
198338.1000	A* 6FX8002-5DN51-1BA0	10.0	(4G6+(2×1.5))	16.1
198339.1000	A* 6FX8002-5DN61-1BA0	10.0	(4G10+(2×1.5))	19.5
SINAMICS, full thread/Booksize				
198310.1000	A* 6FX8002-5DS01-1BA0	10.0	(4G1.5+(2×1.5))	11.4
198311.1000	A* 6FX8002-5DS11-1BA0	10.0	(4G2.5+(2×1.5))	12.9
198312.1000	A* 6FX8002-5DS21-1BA0	10.0	(4G1.5+(2×1.5))	11.4
198313.1000	A* 6FX8002-5DS31-1BA0	10.0	(4G2.5+(2×1.5))	12.9
198314.1000	A* 6FX8002-5DS41-1BA0	10.0	(4G4+(2×1.5))	14.5
198315.1000	A* 6FX8002-5DS51-1BA0	10.0	(4G6+(2×1.5))	16.1
198316.1000	A* 6FX8002-5DS61-1BA0	10.0	(4G10+(2×1.5))	19.5

Servo cable assemblies with brake pairs for C-tracks

According to SIEMENS 6FX8002 standard Base cable



Application

- Base cable for Siemens servo drives
- Through full PUR jacket and TPE conductor insulation optimally suited for c-tracks, extremely harsh operating conditions and aggressive coolants and lubricants
- Especially for industrial environments, machines and plants

Properties

- Silicone free
- RoHS compliant

Construction

Jacket material	PUR
Surface	matte, adhesion-free
Jacket color	orange RAL 2003

Technical data

Rated voltage U_N	1000 V 80 °C
Temperature range fixed	-40 °C ... +80 °C
Temperature range moving	-25 °C ... +80 °C
Minimum bending radius fixed	6×D
Minimum bending radius moving	10×D
Burning behavior according to	IEC 60332-1 DIN EN 50265-2 VDE 0482 Part 265-2 UL 1581 part 1080 VW-1 UL FT1 EN 50267-2-1 EN 60684-2
Halogen free according to	cURus
Certifications	* Siemens article designations are registered trademarks of Siemens AG, and are for reference purposes only
Note	

Part No.	SIEMENS designation*	Cable length m	Number of conductors/cross-section	Outer Ø mm
SIMODRIVE, full thread/open end				
198460.1000	A* 6FX8002-5DA01-1BA0	10.0	(4G1.5+(2×1.5))	11.4
198480.1000	A* 6FX8002-5DA11-1BA0	10.0	(4G2.5+(2×1.5))	12.9
198840.1000	A* 6FX8002-5DA13-1BA0	10.0	(4G10+(2×1.5))	19.5
198500.1000	A* 6FX8002-5DA21-1BA0	10.0	(4G1.5+(2×1.5))	11.4
198870.1000	A* 6FX8002-5DA23-1BA0	10.0	(4G16+(2×1.5))	23.6
198530.1000	A* 6FX8002-5DA31-1BA0	10.0	(4G2.5+(2×1.5))	12.9
198880.1000	A* 6FX8002-5DA33-1BA0	10.0	(4G25+(2×1.5))	28.5
198560.1000	A* 6FX8002-5DA41-1BA0	10.0	(4G4+(2×1.5))	14.5
198349.1000	A* 6FX8002-5DA43-1BA0	10.0	(4G35+(2×1.5))	32.0
198570.1000	A* 6FX8002-5DA51-1BA0	10.0	(4G6+(2×1.5))	16.1
198580.1000	A* 6FX8002-5DA61-1BA0	10.0	(4G10+(2×1.5))	19.5
SINAMICS, full thread/open end				
198075.1000	A* 6FX8002-5DG01-1BA0	10.0	(4G1.5+(2×1.5))	11.4
198085.1000	A* 6FX8002-5DG11-1BA0	10.0	(4G2.5+(2×1.5))	11.4
198275.1000	A* 6FX8002-5DG13-1BA0	10.0	(4G10+(2×1.5))	19.5
198080.1000	A* 6FX8002-5DG21-1BA0	10.0	(4G1.5+(2×1.5))	11.4
198276.1000	A* 6FX8002-5DG23-1BA0	10.0	(4G16+(2×1.5))	23.6
198090.1000	A* 6FX8002-5DG31-1BA0	10.0	(4G2.5+(2×1.5))	12.9
198277.1000	A* 6FX8002-5DG33-1BA0	10.0	(4G25+(2×1.5))	28.5
198095.1000	A* 6FX8002-5DG41-1BA0	10.0	(4G4+(2×1.5))	14.5
198278.1000	A* 6FX8002-5DG43-1BA0	10.0	(4G35+(2×1.5))	32.0
198100.1000	A* 6FX8002-5DG51-1BA0	10.0	(4G6+(2×1.5))	16.1
198279.1000	A* 6FX8002-5DG53-1BA0	10.0	(4G50+(2×1.5))	37.3
198115.1000	A* 6FX8002-5DG61-1BA0	10.0	(4G10+(2×1.5))	19.5
198263.1000	A* 6FX8002-5DS14-1BA0	10.0	(4G10+(2×1.5))	19.5
198267.1000	A* 6FX8002-5DS23-1BA0	10.0	(4G16+(2×1.5))	23.6
198259.1000	A* 6FX8002-5DS54-1BA0	10.0	(4G6+(2×1.5))	16.1
198262.1000	A* 6FX8002-5DS64-1BA0	10.0	(4G10+(2×1.5))	19.5

Servo cable assemblies without brake pairs for C-tracks

According to SIEMENS 6FX8002 standard
Extension



Application

- Extension cable, for SIEMENS SERVO drives
- Through full PUR jacket and TPE conductor insulation optimally suited for c-tracks, extremely harsh operating conditions and aggressive coolants and lubricants

Properties

- Silicone free
- RoHS compliant

Construction

Jacket material
Surface
Jacket color

PUR
matte, adhesion-free
orange RAL 2003

Technical data

Rated voltage U_N

1000 V 80 °C

Temperature range fixed
Temperature range moving
Minimum bending radius fixed
Minimum bending radius moving
Burning behavior according to

-40 °C ... +80 °C
-25 °C ... +80 °C
6×D
10×D
IEC 60332-1
DIN EN 50265-2
VDE 0482 Part 265-2
UL 1581 part 1080 VW-1
UL FT1
EN 50267-2-1
EN 60684-2

Halogen free according to

Certifications

Note

cURus

* Siemens article designations are registered trademarks of Siemens AG, and are for reference purposes only

Part No.	SIEMENS designation*	Cable length m	Number of conductors/cross- section	Outer Ø mm
SINAMICS/SIMODRIVE, full thread				
198820.1000	A* 6FX8002-5CA05-1BA0	10.0	(4G1.5)	8.6
198985.1000	A* 6FX8002-5CA15-1BA0	10.0	(4G2.5)	10.8
198765.1000	A* 6FX8002-5CA28-1BA0	10.0	(4G1.5)	8.6
198995.1000	A* 6FX8002-5CA38-1BA0	10.0	(4G2.5)	10.8
198015.1000	A* 6FX8002-5CA48-1BA0	10.0	(4G4)	12.2
198020.1000	A* 6FX8002-5CA58-1BA0	10.0	(4G6)	14.0
198030.1000	A* 6FX8002-5CA68-1BA0	10.0	(4G10)	17.6
198216.1000	A* 6FX8002-5CX18-1BA0	10.0	(4G10)	17.6
198217.1000	A* 6FX8002-5CX28-1BA0	10.0	(4G16)	21.2
SINAMICS, speed-connect				
198204.1000	A* 6FX8002-5CN05-1BA0	10.0	(4G1.5)	8.6

Servo cable assemblies with brake pairs for C-tracks

According to SIEMENS 6FX8002 standard Extension



Application

- Extension cable, for SIEMENS SERVO drives
- Through full PUR jacket and TPE conductor insulation optimally suited for c-tracks, extremely harsh operating conditions and aggressive coolants and lubricants
- Especially for industrial environments, machines and plants

Properties

- Silicone free
- RoHS compliant

Construction

Jacket material PUR
Surface matte, adhesion-free
Jacket color orange RAL 2003

Rated voltage U_N 1000 V 80 °C
Temperature range fixed -40 °C ... +80 °C
Temperature range moving -25 °C ... +80 °C
Minimum bending radius fixed 6×D
Minimum bending radius moving 10×D
Burning behavior according to IEC 60332-1
DIN EN 50265-2
VDE 0482 Part 265-2
UL 1581 part 1080 VW-1
UL FT1
EN 50267-2-1

Halogen free according to Certifications

Note

cURus
* Siemens article designations are registered trademarks of Siemens AG, and are for reference purposes only

Technical data

Part No.	SIEMENS designation*	Cable length m	Number of conductors/cross-section	Outer Ø mm
SINAMICS/SIMODRIVE, full thread				
198730.1000	A* 6FX8002-5DA05-1BA0	10.0	(4G1.5+(2×1.5))	11.4
198990.1000	A* 6FX8002-5DA15-1BA0	10.0	(4G2.5+(2×1.5))	12.9
198790.1000	A* 6FX8002-5DA28-1BA0	10.0	(4G1.5+(2×1.5))	11.4
198800.1000	A* 6FX8002-5DA38-1BA0	10.0	(4G2.5+(2×1.5))	12.9
198005.1000	A* 6FX8002-5DA48-1BA0	10.0	(4G4+(2×1.5))	14.5
198010.1000	A* 6FX8002-5DA58-1BA0	10.0	(4G6+(2×1.5))	16.1
198025.1000	A* 6FX8002-5DA68-1BA0	10.0	(4G10+(2×1.5))	19.5
198248.1000	A* 6FX8002-5DX18-1BA0	10.0	(4G10+(2×1.5))	19.5
198249.1000	A* 6FX8002-5DX28-1BA0	10.0	(4G16+(2×1.5))	23.6
198252.1000	A* 6FX8002-5DX38-1BA0	10.0	(4G25+(2×1.5))	28.5
198187.1000	A* 6FX8002-5DX48-1BA0	10.0	(4G35+(2×1.5))	32.0
198254.1000	A* 6FX8002-5DX58-1BA0	10.0	(4G50+(2×1.5))	37.3
SINAMICS, speed-connect				
198735.1000	A* 6FX8002-5DN05-1BA0	10.0	(4G1.5+(2×1.5))	11.4

Signal cables for C-tracks

According to SIEMENS 6FX8002 standard Base cable DRIVE-CLIQ



Application

- Signal cable for SIEMENS SERVO drives
- Through full PUR jacket and TPE conductor insulation optimally suited for c-tracks, extremely harsh operating conditions and aggressive coolants and lubricants
- Especially for industrial environments, machines and plants

Properties

- Very good alternating bending strength
- Hydrolysis-resistant, microbe-resistant, and rot-resistant
- Weathering, ozone and UV resistant (normal lighting conditions)
- Industrial and salt water resistant
- Largely resistant to oils, greases, alcohol-free benzines and kerosene
- Silicone free
- RoHS compliant

Construction

Jacket material Special PUR
Surface matte, adhesion-free
Jacket color green RAL 6018

Technical data

Rated voltage U_N 30 V 80 °C
Temperature range fixed -40 °C ... +80 °C
Temperature range moving -25 °C ... +80 °C
Minimum bending radius fixed 6xD
Minimum bending radius moving 12xD
Burning behavior according to IEC 60332-1
DIN EN 50265-2
VDE 0482 Part 265-2
UL VW-1
UL FT1

Certifications

Note

Note

cURus
Permitted total cable length ≤ 100 m
(6FX5...) or ≤ 75 m (6FX8...)
* Siemens article designations are registered trademarks of Siemens AG, and are for reference purposes only

Part No.	SIEMENS designation*	Cable length m	Number of conductors/cross-section	Outer Ø mm
SINAMICS				
198476.1000	A* 6FX8002-2DC40-1BA0	10.0	(2×2×AWG26+1×2×AWG22)	6.8
198478.1000	A* 6FX8002-2DC42-1BA0	10.0	(2×2×AWG26+1×2×AWG22)	6.8
198483.1000	A* 6FX8002-2DC44-1BA0	10.0	(2×2×AWG26+1×2×AWG22)	6.8
198485.1000	A* 6FX8002-2DD40-1BA0	10.0	(2×2×AWG26+1×2×AWG22)	6.8
198487.1000	A* 6FX8002-2DD42-1BA0	10.0	(2×2×AWG26+1×2×AWG22)	6.8
198489.1000	A* 6FX8002-2DD44-1BA0	10.0	(2×2×AWG26+1×2×AWG22)	6.8
198503.1000	A* 6FX8002-2DC48-1BA0	10.0	(2×2×AWG26+1×2×AWG22)	6.8
198505.1000	A* 6FX8002-2DD48-1BA0	10.0	(2×2×AWG26+1×2×AWG22)	6.8

Signal cables for C-tracks

According to SIEMENS 6FX8002 standard Base cable DRIVE-CLIQ



Application

- Signal cable for SIEMENS SERVO drives
- Through full PUR jacket and TPE conductor insulation optimally suited for c-tracks, extremely harsh operating conditions and aggressive coolants and lubricants
- Especially for industrial environments, machines and plants

Properties

- Very good alternating bending strength
- Hydrolysis-resistant, microbe-resistant, and rot-resistant
- Weathering, ozone and UV resistant (normal lighting conditions)
- Industrial and salt water resistant
- Largely resistant to oils, greases, alcohol-free benzines and kerosene
- Silicone free
- RoHS compliant

Construction

Jacket material Special PUR
Surface matte, adhesion-free
Jacket color green RAL 6018

Technical data

Rated voltage U_N 30 V 80 °C
Temperature range fixed -40 °C ... +80 °C
Temperature range moving -25 °C ... +80 °C
Minimum bending radius fixed 6×D
Minimum bending radius moving 12×D
Burning behavior according to IEC 60332-1
DIN EN 50265-2
VDE 0482 Part 265-2
UL VW-1
UL FT1

Certifications

Note

Note

cURus
The total length of the DRIVE-CLIQ train does not exceed more than 30 m.
* Siemens article designations are registered trademarks of Siemens AG, and are for reference purposes only

Part No.	SIEMENS designation*	Cable length m	Number of conductors/cross- section	Outer Ø mm
SINAMICS				
198494.1000	A* 6FX8002-2DC46-1BA0	10.0	(2×2×AWG26+1×2×AWG22)	6.8
198496.1000	A* 6FX8002-2DC30-1BA0	10.0	(2×2×AWG26+1×2×AWG22)	6.8
198507.1000	A* 6FX8002-2DC36-1BA0	10.0	(2×2×AWG26+1×2×AWG22)	6.8

Signal cable assemblies for C-tracks

According to SIEMENS 6FX8002 standard
Base cable DRIVE-CLIQ



Application

- Resolver cable
- Through full PUR jacket and TPE conductor insulation optimally suited for c-tracks, extremely harsh operating conditions and aggressive coolants and lubricants

Properties

- Silicone free
- RoHS compliant

Construction

Jacket material
Surface
Jacket color

PUR
matte, adhesion-free
green RAL 6018

Rated voltage U_N
Temperature range fixed
Temperature range moving
Minimum bending radius fixed
Minimum bending radius moving
Burning behavior according to

30 V 80 °C
-40 °C ... +80 °C
-25 °C ... +80 °C
6×D
12×D
IEC 60332-1
DIN EN 50265-2
VDE 0482 Part 265-2
UL 1581 part 1080 VW-1
UL FT1
EN 50267-2-1

Halogen free according to
Certifications

Note

cURus

* Siemens article designations are registered trademarks of Siemens AG, and are for reference purposes only

Technical data

Part No.	SIEMENS designation*	Cable length m	Number of conductors/cross- section	Outer Ø mm
SINAMICS				
198890.1000	A* 6FX8002-2DC00-1BA0	10.0	(2×2×0.15+1×2×0.38)	6.8
198900.1000	A* 6FX8002-2DC10-1BA0	10.0	(2×2×0.15+1×2×0.38)	6.8
198910.1000	A* 6FX8002-2DC20-1BA0	10.0	(2×2×0.15+1×2×0.38)	6.8

Signal cable assemblies for C-tracks

According to SIEMENS 6FX8002 standard Base cable



Application

- Resolver cable
- Through full PUR jacket and TPE conductor insulation optimally suited for c-tracks, extremely harsh operating conditions and aggressive coolants and lubricants

Properties

- Silicone free
- RoHS compliant

Construction

Jacket material
Surface
Jacket color

PUR
matte, adhesion-free
green RAL 6018

Rated voltage U_N
Temperature range fixed
Temperature range moving
Minimum bending radius fixed
Minimum bending radius moving
Burning behavior according to

30 V 80 °C
-40 °C ... +80 °C
-25 °C ... +80 °C
6xD
12xD
IEC 60332-1
DIN EN 50265-2
VDE 0482 Part 265-2
UL 1581 part 1080 VW-1
UL FT1
EN 50267-2-1

Halogen free according to
Certifications

Note

cURus
* Siemens article designations are registered trademarks of Siemens AG, and are for reference purposes only

Technical data

Part No.	SIEMENS designation*	Cable length m	Number of conductors/cross- section	Outer Ø mm
SIMODRIVE base cable				
198110.1000	A* 6FX8002-2AD00-1BA0	10.0	(2×0.5+3×(2×0.14)+4×0.14)	8.6
198830.1000	A* 6FX8002-2AH00-1BA0	10.0	(4×0.5+4×2×0.38)	9.0
198120.1000	A* 6FX8002-2CA11-1BA0	10.0	(4×0.5+4×2×0.38)	9.0
198130.1000	A* 6FX8002-2CA15-1BA0	10.0	(2×0.5+3×(2×0.14)+4×0.14)	8.6
198628.1000	A* 6FX8002-2CA31-1BA0	10.0	(2×0.5+4×0.23+3×(2×0.14)+4×0.14)	9.5
198850.1000	A* 6FX8002-2CA51-1BA0	10.0	(2×0.5+3×(2×0.14)+4×0.14)	8.6
198150.1000	A* 6FX8002-2CA61-1BA0	10.0	(3×(2×0.14)+2×0.5+4×0.14)	8.6
198191.1000	A* 6FX8002-2CB31-1BA0	10.0	(12×0.23)	7.4
198200.1000	A* 6FX8002-2CB51-1BA0	10.0	(4×0.5+4×2×0.38)	9.0
198210.1000	A* 6FX8002-2CC11-1BA0	10.0	(4×0.5+4×2×0.38)	9.0
198220.1000	A* 6FX8002-2CD01-1BA0	10.0	(4×0.5+4×2×0.38)	9.0
198240.1000	A* 6FX8002-2CF02-1BA0	10.0	(2×0.5+4×0.14+3×(2×0.14))	8.6
198170.1000	A* 6FX8002-2CG00-1BA0	10.0	(4×0.5+4×2×0.38)	9.0
198250.1000	A* 6FX8002-2CH00-1BA0	10.0	(2×0.5+4×0.14+3×(2×0.14))	8.6
198270.1000	A* 6FX8002-2EQ00-1BA0	10.0	(2×0.5+4×0.23+3×(2×0.14)+4×0.14)	9.8
198280.1000	A* 6FX8002-2EQ10-1BA0	10.0	(2×0.5+4×0.23+3×(2×0.14)+4×0.14)	9.5
198140.1000	A* 6FX8002-2CA21-1BA0	10.0	(2×0.5+3×(2×0.14)+4×0.14)	8.6
198260.1000	A* 6FX8002-2CE07-1BA0	10.0	(2×0.5+4×0.23+3×(2×0.14)+4×0.14)	9.0
SIMODRIVE extension				
198160.1000	A* 6FX8002-2CA34-1BA0	10.0	(2×0.5+4×0.23+3×(2×0.14)+4×0.14)	9.5
198740.1000	A* 6FX8002-2CF04-1BA0	10.0	(2×0.5+4×0.14+3×(2×0.14))	8.6
198700.1000	A* 6FX8002-2EQ14-1BA0	10.0	(2×0.5+3×(2×0.14)+4×0.23+4×0.14)	9.5
198105.1000	A* 6FX8002-2AD04-1BA0	10.0	(2×0.5+3×(2×0.14)+4×0.14)	8.6
198295.1000	A* 6FX8002-2CB54-1BA0	10.0	(4×0.5+4×2×0.38)	9.0

Pre-fabricated front-end plug S7

S7 Plug with screw termination



Application

- Wiring from Siemens Simatic PLC/S7

Properties

- Cable core with S7 connector
- Completely wired, 2. cables run at 90° to connector

Construction

Jacket color

dark blue RAL 5010

Technical data

Packaging

3 m or 5 m
Other lengths are available upon request

Part No.	Cable core	Cable length m	Number of conductors/cross-section
S7 Plug with screw termination			
197457	A* 20-pin	3.0	20x0.75
197458	A* 20-pin	5.0	20x0.75
S7 Plug with Easy-Connect			
197500	A* 40-pin	3.0	40x0.5
197501	A* 40-pin	5.0	40x0.5
197502	A* 40-pin	3.0	40x0.75
197503	A* 40-pin	5.0	40x0.75

Notes

Internet of Things

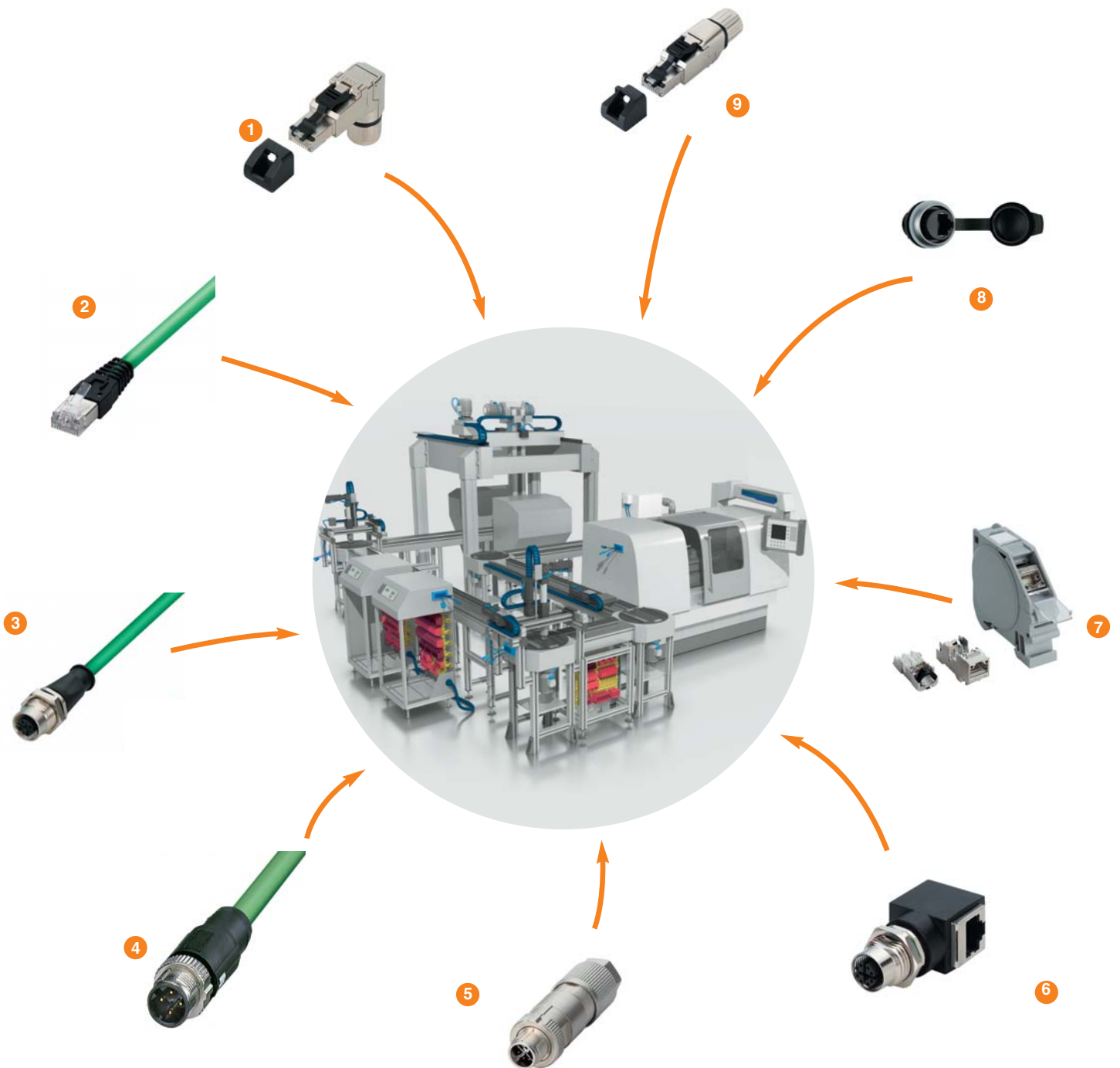

- 1 RJ45 industrial connector, angled
- 2 RJ45 connector
- 3 M12 panel connector
- 4 M12 connector

- 5 M12 Male X-coded
- 6 M12 / RJ45 control cabinet bushing
- 7 RJ45 Module holder
- 8 RJ45 panel connector for front installation
- 9 RJ45 connector

Actuator sensor interface

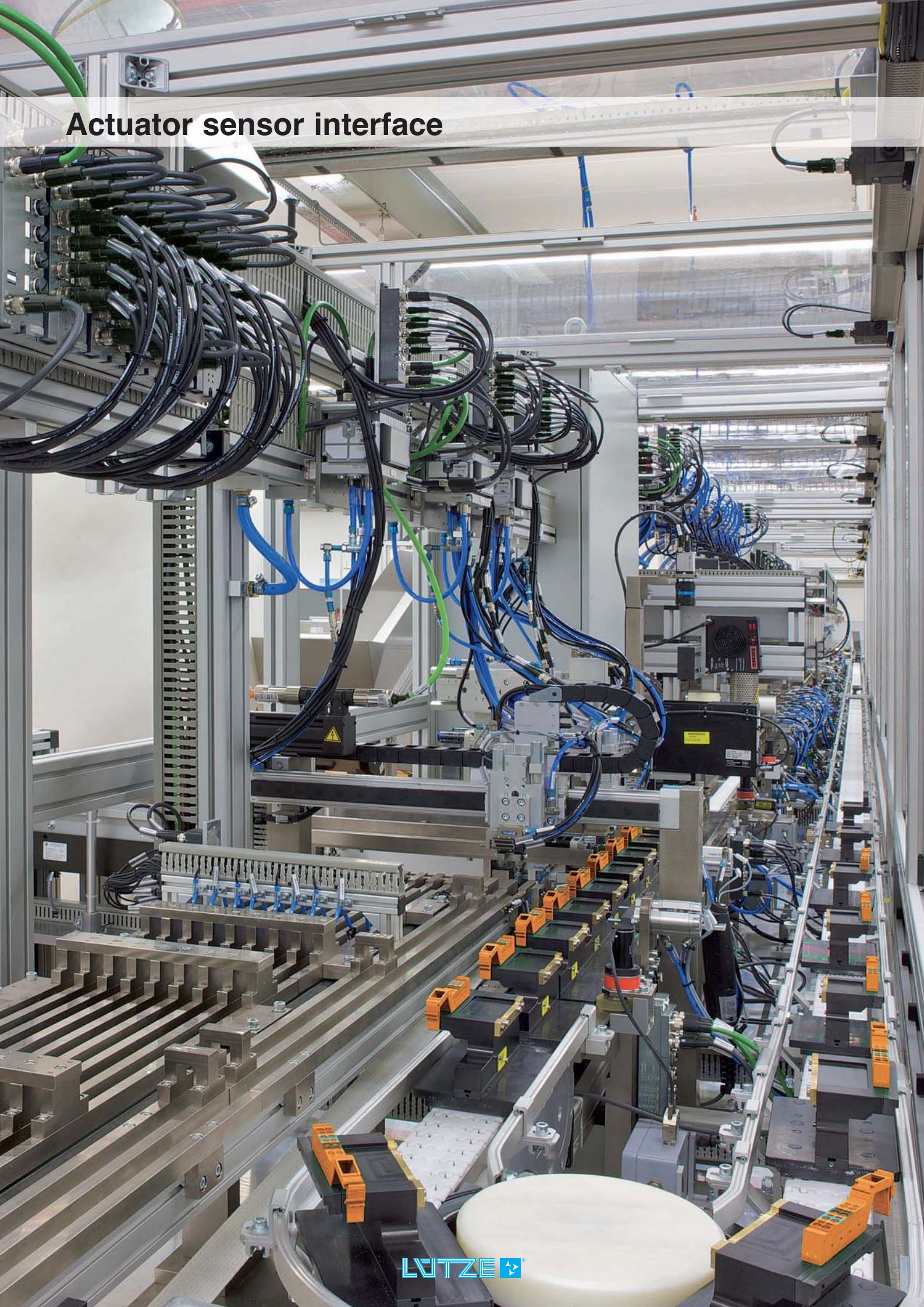

Actuator sensor interface



Actuator sensor cables	Seite
M12, RJ45 - Network cables (PROFINET, Ethernet)	59 - 61
RJ45 Ethernet Patch cables Cat. 5e / Cat. 6 / Cat. 6A	62
M12 / open End - Network cables (PROFINET, Ethernet)	63, 65
M12 / M12 - Network cables (PROFINET, Ethernet)	64
RJ45 / M12 - Network cables (PROFINET, Ethernet)	66
RJ45 / RJ45 - Network cables (PROFINET, Ethernet)	67 - 69
M8 / Open End - Cables	70 - 73
M8 / M8 - Cables	74 - 76
M12 Cables	77 - 88
M12 / M12 - Cables	89 - 92
M12 Valve connectors	93 - 94



Connector, field assembly	
M8 - Connectors	95 - 96
M12 - Connectors	97 - 101
M12, M12/M8 - Connector T piece	102
M12 - Connectors, shielded	103 - 107
RJ45 Connectors	108 - 110
RJ45 Module holder	111



Panel connectors	
M8 and M12 Panel connectors	112 - 113
USB - Panel connectors	114 - 115
RJ45 - Panel connectors	116 - 118

Accessories	
M12 Protective cover	119

Product photos

The product photos are not to scale and do not accurately depict every single product detail.

CE: These products comply with the EU Low Voltage Directive 2014/35/EU
The Low Voltage Directive applies as of 50 V AC or 75 V DC

Actuator sensor interface - Network cables PROFINET

Male RJ45 straight to female M12 straight with PVC cable shielded, Cat 5e Self-locking screw connection M12



Construction

Number of conductors/cross-section (2×2×AWG22/7)
 Number of conductors 4
 Jacket material PVC
 Jacket color green RAL 6018
 Minimum bending radius fixed 6×D
 Minimum bending radius moving 12×D

Technical data

Operating voltage max. 50 V
 Rated current 1.5 A

Form male 1
 Form male 2
 Degree of protection IP20
 Color of the housing black
 Mounting Breakaway torque 0.4 Nm
 Temperature range connector -25 °C ... +85 °C
 Temperature range fixed -30 °C ... +80 °C
 Temperature range moving -5 °C ... +70 °C
Accessories

RJ45
 M 12
 IP20
 black
 Breakaway torque 0.4 Nm
 -25 °C ... +85 °C
 -30 °C ... +80 °C
 -5 °C ... +70 °C
Torque setting tool M 12: Part-No. 490091 | DM-SET M12 | PU: 1 unit

Part No.	Type	Pole number	Coding	Cable length m	Cable diameter mm	PU (units)
192014.0030	S* STG4-RJ45/STG4-M12/ PN PVC 0,3M	4	D	0.3	6.5	1
192014.0060	S* STG4-RJ45/STG4-M12/ PN PVC 0,6M	4	D	0.6	6.5	1
192014.0100	S* STG4-RJ45/STG4-M12/ PN PVC 1,0M	4	D	1.0	6.5	1
192014.0150	S* STG4-RJ45/STG4-M12/ PN PVC 1,5M	4	D	1.5	6.5	1
192014.0200	S* STG4-RJ45/STG4-M12/ PN PVC 2,0M	4	D	2.0	6.5	1
192014.0500	S* STG4-RJ45/STG4-M12/ PN PVC 5,0M	4	D	5.0	6.5	1
192014.1000	S* STG4-RJ45/STG4-M12/ PN PVC 10,0M	4	D	10.0	6.5	1
192014.1500	A* STG4-RJ45/STG4-M12/ PN PVC 15,0M	4	D	15.0	6.5	1
192014.2000	A* STG4-RJ45/STG4-M12/ PN PVC 20,0M	4	D	20.0	6.5	1

Pin layout

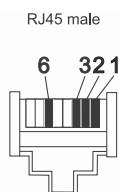
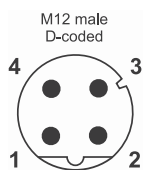

Circuit diagram

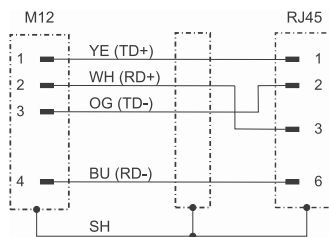

Actuator sensor interface - Network cables PROFINET

Male RJ45 straight to female RJ45 straight with PVC cable shielded, Cat 5e 4-pin



Construction

Number of conductors/cross-section	(2×2×AWG22/7)
Number of conductors	4
Jacket material	PVC
Jacket color	green RAL 6018
Minimum bending radius fixed	6×D
Minimum bending radius moving	12×D

Operating voltage max.	50 V
Rated current	1.5 A
Form male 1	RJ45 male straight
Form male 2	RJ45 male straight
Degree of protection	IP20
Color of the housing	black
Temperature range connector	-25 °C ... +85 °C
Temperature range fixed	-30 °C ... +80 °C
Temperature range moving	-5 °C ... +70 °C

Technical data

Part No.	Type	Pole number	Cable length m	Cable diameter mm	PU (units)
192016.0030	S* STG4-RJ45/STG4-RJ45/PN PVC 0,3M	4	0.3	6.5	1
192016.0060	S* STG4-RJ45/STG4-RJ45/PN PVC 0,6M	4	0.6	6.5	1
192016.0100	S* STG4-RJ45/STG4-RJ45/PN PVC 1,0M	4	1.0	6.5	1
192016.0150	S* STG4-RJ45/STG4-RJ45/PN PVC 1,5M	4	1.5	6.5	1
192016.0200	S* STG4-RJ45/STG4-RJ45/PN PVC 2,0M	4	2.0	6.5	1
192016.0500	S* STG4-RJ45/STG4-RJ45/PN PVC 5,0M	4	5.0	6.5	1
192016.1000	S* STG4-RJ45/STG4-RJ45/PN PVC 10,0M	4	10.0	6.5	1
192016.1500	S* STG4-RJ45/STG4-RJ45/PN PVC 15,0M	4	15.0	6.5	1
192016.2000	S* STG4-RJ45/STG4-RJ45/PN PVC 20,0M	4	20.0	6.5	1

Pin layout

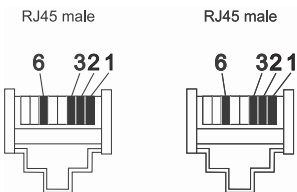

Circuit diagram

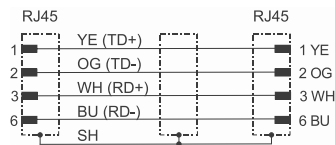

Actuator sensor interface - Network cables Ethernet

Male RJ45 straight to female RJ45 straight with PVC cable shielded, Cat 5e 8-pin



Construction

Number of conductors/cross-section (4x2xAWG26/7)
 Number of conductors 8
 Jacket material PVC
 Jacket color green RAL 6018
 Minimum bending radius fixed 6xD
 Minimum bending radius moving 12xD

Operating voltage max. 50 V
 Rated current 1.5 A
 Form male 1 RJ45 male straight
 Form male 2 RJ45 male straight
 Degree of protection IP20
 Color of the housing black
 Temperature range connector -25 °C ... +85 °C
 Temperature range fixed -30 °C ... +70 °C
 Temperature range moving -5 °C ... +70 °C

Technical data

Part No.	Type	Pole number	Cable length m	Cable diameter mm	PU (units)
192018.0030	S* STG8-RJ45/STG8-RJ45/ET PVC 0,3M	8	0.3	6.3	1
192018.0060	S* STG8-RJ45/STG8-RJ45/ET PVC 0,6M	8	0.6	6.3	1
192018.0100	S* STG8-RJ45/STG8-RJ45/ET PVC 1,0M	8	1.0	6.3	1
192018.0150	S* STG8-RJ45/STG8-RJ45/ET PVC 1,5M	8	1.5	6.3	1
192018.0200	S* STG8-RJ45/STG8-RJ45/ET PVC 2,0M	8	2.0	6.3	1
192018.0500	S* STG8-RJ45/STG8-RJ45/ET PVC 5,0M	8	5.0	6.3	1
192018.1000	S* STG8-RJ45/STG8-RJ45/ET PVC 10,0M	8	10.0	6.3	1
192018.1500	S* STG8-RJ45/STG8-RJ45/ET PVC 15,0M	8	15.0	6.3	1
192018.2000	S* STG8-RJ45/STG8-RJ45/ET PVC 20,0M	8	20.0	6.3	1

Pin layout

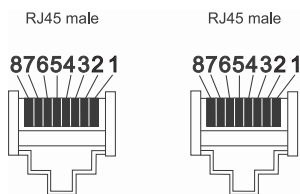

Circuit diagram

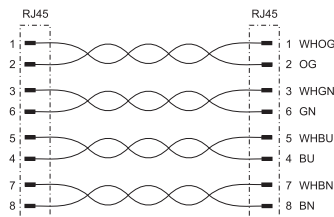

Actuator sensor interface - Patch cable, shielded

Patch cable Cat.5e/Cat.6/Cat.6_A



Application

- Ethernet network wiring

Properties

- Straight connector
- Assignment according to EIA/TIA 568B
- Moulded sleeve with length imprint (not suitable for drag chain and industrial design)
- Various colors available

- catch protection

Technical data

Operating voltage max.	50 V
Connector	Shielded RJ45, 1,27µm AU
Wiring	1:1
Compatibility	Fully plug compatible to IEC 60603-7
Ethernet Key	SF/UTP
Burning behavior according to	IEC 60332-1

Part No.	Number of conductors/cross-section	Jacket color	Sleeve color	Wiring	Temperature range fixed	Cable length m
Cat.5e PVC						
192000.0100	S* (4x2xAWG26/7)	grey	grey	1:1	-5 °C ... +70 °C	1.0
192022.0100	S* (4x2xAWG26/7)	blue	blue	1:1	-5 °C ... +70 °C	1.0
192030.0100	S* (4x2xAWG26/7)	green	green	1:1	-5 °C ... +70 °C	1.0
192050.0100	S* (4x2xAWG26/7)	grey	red	Crossover	-5 °C ... +70 °C	1.0
Cat.5e PVC UL						
192010.0100	S* (4x2xAWG26/7)	grey	grey	1:1	-5 °C ... +70 °C	1.0
Cat.6A LSZH						
192353.0100	S* (4x2xAWG26/7)	grey	grey	1:1	-20 °C ... +75 °C	1.0
192355.0100	S* (4x2xAWG26/7)	blue	blue	1:1	-20 °C ... +75 °C	1.0
192342.0100	S* (4x2xAWG26/7)	yellow	yellow	1:1	-20 °C ... +75 °C	1.0
192352.0100	S* (4x2xAWG26/7)	green	green	1:1	-20 °C ... +75 °C	1.0
192354.0100	S* (4x2xAWG26/7)	red	red	1:1	-20 °C ... +75 °C	1.0
Cat.6 industrial version PUR						
192201.0100	S* (4x2xAWG27/7)	red	black	1:1	-30 °C ... +75 °C	1.0

Pin layout

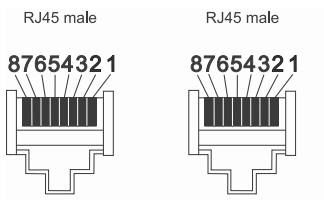

Circuit diagram

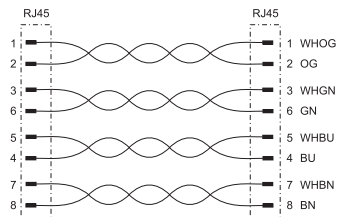

Actuator sensor interface - Network cables PROFINET

**Male M12 straight with PUR cable, shielded 360°, open end
Cat.5e, D-coded, self-locking screw connection
C-track compatible, halogen free**



Construction

Number of conductors/cross-section 1 × 4 × AWG 22/7
Number of conductors 4
Jacket material PUR
Jacket color green RAL 6018
Minimum bending radius moving 12×D

Technical data

Rated voltage U_N AC/DC 24 V
Operating voltage max. 60 V
Rated current 4 A

Form male 1
Form male 2
Degree of protection
Color of the housing
Mounting
Storage temperature range
Temperature range connector
Temperature range fixed
Temperature range moving
Accessories

M 12 male straight
line end open
IP65/67
black
Breakaway torque 0.4 Nm
-40 °C ... +90 °C
-25 °C ... +90 °C
-40 °C ... +70 °C
-30 °C ... +70 °C
Torque setting tool M 12: Part-No. 490091 | DM-SET M12 | PU: 1 unit

Part No.	Type	Pole number	Coding	Cable length m	Cable diameter mm	PU (units)
475300.0200	S* STG4-M12/PN 2M-PUR	4	D	2.0	6.5	1
475300.0500	S* STG4-M12/PN 5M-PUR	4	D	5.0	6.5	1
475300.1000	S* STG4-M12/PN 10M-PUR	4	D	10.0	6.5	1
475300.1500	S* STG4-M12/PN 15M-PUR	4	D	15.0	6.5	1
475300.2000	S* STG4-M12/PN 20M-PUR	4	D	20.0	6.5	1

Pin layout

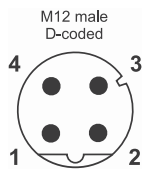

Circuit diagram

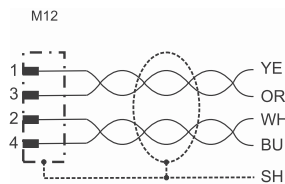

Actuator sensor interface - Network cables PROFINET

Male M12 straight on male M12 straight with PUR cable, shielded 360°
 Cat.5e, D-coded, self-locking screw connection
 C-track compatible, halogen free



Construction
 Number of conductors/cross-section 1 × 4 × AWG 22/7
 Number of conductors 4
 Jacket material PUR
 Jacket color green RAL 6018
 Minimum bending radius moving 12×D

Technical data
 Rated voltage U_N AC/DC 24 V
 Rated voltage max. 30 V
 Operating voltage max. 48 V
 Rated current 4 A

Form male 1
 Form male 2
 Degree of protection
 Color of the housing
 Mounting
 Storage temperature range
 Temperature range connector
 Temperature range fixed
 Temperature range moving
Accessories

M 12 male straight
 M 12 male straight
 IP65/67
 black
 Breakaway torque 0.4 Nm
 -30 °C ... +90 °C
 -25 °C ... +90 °C
 -40 °C ... +80 °C
 -30 °C ... +70 °C
Torque setting tool M 12: Part-No. 490091 | DM-SET M12 | PU: 1 unit

Part No.	Type	Pole number	Coding	Cable length m	Cable diameter mm	PU (units)
475400.0030	S* STG4-M12/STG4-M12/ PN 0,3M PUR	4	D	0.3	6.5	1
475400.0060	S* STG4-M12/STG4-M12/ PN 0,6M PUR	4	D	0.6	6.5	1
475400.0100	S* STG4-M12/STG4-M12/ PN 1,0M PUR	4	D	1.0	6.5	1
475400.0150	S* STG4-M12/STG4-M12/ PN 1,5M PUR	4	D	1.5	6.5	1
475400.0200	S* STG4-M12/STG4-M12/ PN 2,0M PUR	4	D	2.0	6.5	1
475400.0500	S* STG4-M12/STG4-M12/ PN 5,0M PUR	4	D	5.0	6.5	1
475400.1000	S* STG4-M12/STG4-M12/ PN 10,0M PUR	4	D	10.0	6.5	1
475400.1500	S* STG4-M12/STG4-M12/ PN 15,0M PUR	4	D	15.0	6.5	1
475400.2000	S* STG4-M12/STG4-M12/ PN 20,0M PUR	4	D	20.0	6.5	1

Pin layout

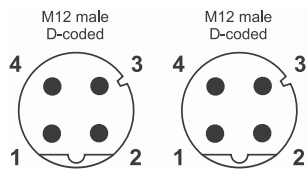

Circuit diagram

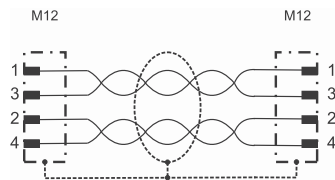

Actuator sensor interface - Network cables PROFINET

M12 panel connectors using PG9 thread for rear panel installation, PUR cable, open end
 Cat.5e, female - D coded
 C-track compatible, halogen free



Construction

Number of conductors/cross-section 1×4×AWG22/7
 Jacket material PUR
 Jacket color green RAL 6018
 Minimum bending radius moving 10×D

Technical data

Rated voltage U_N AC/DC 24 V
 Rated voltage max. 30 V
 Operating voltage max. 48 V

Rated current 4 A
 Form male 1
 Degree of protection IP65/67
 Storage temperature range -40 °C ... +90 °C
 Temperature range connector -25 °C ... +90 °C
 Temperature range fixed -40 °C ... +80 °C
 Temperature range moving -30 °C ... +70 °C

Accessories

Torque setting tool M 12: Part-No. 490091 | DM-SET M12 | PU: 1 unit

Part No.	Type	Pole number	Coding	Cable length m	Cable diameter mm	PU (units)
475500.0200	S* KUGE4-M12/PN 2M PUR	4	D	2.0	6.5	1
475500.0500	S* KUGE4-M12/PN 5M PUR	4	D	5.0	6.5	1
475500.1000	S* KUGE4-M12/PN 10M PUR	4	D	10.0	6.5	1

Pin layout

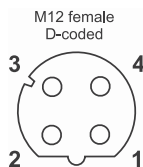

Circuit diagram

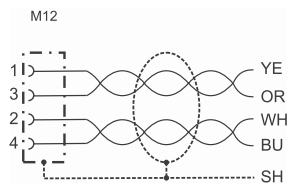

Actuator sensor interface - Network cables PROFINET

Male RJ45 straight to female M12 straight with PUR cable shielded 360°
Cat.5e, D-coded, self-locking screw connection
C-track compatible, halogen free



Construction

Number of conductors/cross-section (2×2×AWG22/7)
 Number of conductors 4
 Jacket material PUR
 Jacket color green RAL 6018
 Minimum bending radius fixed 6×D
 Minimum bending radius moving 12×D

Technical data

Rated voltage U_N DC 24 V
 Operating voltage max. 50 V

Rated current
 Form male 1
 Form male 2
 Degree of protection
 Color of the housing
 Mounting
 Temperature range connector
 Temperature range fixed
 Temperature range moving
Accessories

1.5 A
 RJ45 male straight
 M 12 male straight
 IP20
 black
 Breakaway torque 0.4 Nm
 -25 °C ... +85 °C
 -40 °C ... +80 °C
 -30 °C ... +70 °C
Torque setting tool M 12: Part-No. 490091 | DM-SET M12 | PU: 1 unit

Part No.	Type	Pole number	Coding	Cable length m	Cable diameter mm	PU (units)
192013.0030	S* STG4-RJ45/STG4-M12/ PN PUR 0,3M	4	D	0.3	6.5	1
192013.0060	S* STG4-RJ45/STG4-M12/ PN PUR 0,6M	4	D	0.6	6.5	1
192013.0100	S* STG4-RJ45/STG4-M12/ PN PUR 1,0M	4	D	1.0	6.5	1
192013.0150	S* STG4-RJ45/STG4-M12/ PN PUR 1,5M	4	D	1.5	6.5	1
192013.0200	S* STG4-RJ45/STG4-M12/ PN PUR 2,0M	4	D	2.0	6.5	1
192013.0500	S* STG4-RJ45/STG4-M12/ PN PUR 5,0M	4	D	5.0	6.5	1
192013.1000	S* STG8-RJ45/STG4-M12/ PN CAT5 10,0M PUR	4	D	10.0	6.5	1
192013.1500	S* STG4-RJ45/STG4-M12/ PN PUR 15,0M	4	D	15.0	6.5	1
192013.2000	S* STG4-RJ45/STG4-M12/ PN PUR 20,0M	4	D	20.0	6.5	1

Pin layout

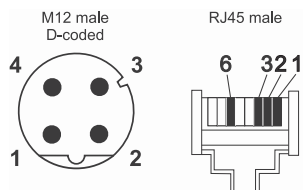

Circuit diagram

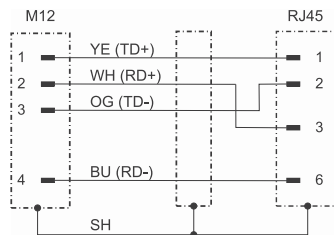

Actuator sensor interface - Network cables PROFINET

Male RJ45 straight to female RJ45 straight with PUR cable shielded, Cat.5e
C-track compatible, halogen free



Construction

Number of conductors/cross-section (2×2×AWG22/7)
Number of conductors 4
Jacket material PUR
Jacket color green RAL 6018
Minimum bending radius fixed 6×D
Minimum bending radius moving 12×D

Operating voltage max. 50 V
Rated current 1.5 A
Form male 1 RJ45 male straight
Form male 2 RJ45 male straight
Degree of protection IP20
Color of the housing black
Temperature range connector -25 °C ... +85 °C
Temperature range fixed -30 °C ... +80 °C
Temperature range moving -30 °C ... +70 °C

50 V
1.5 A
RJ45 male straight
RJ45 male straight
IP20
black
-25 °C ... +85 °C
-30 °C ... +80 °C
-30 °C ... +70 °C

Technical data

Part No.	Type	Pole number	Cable length m	Cable diameter mm	PU (units)
192015.0030	S* STG4-RJ45/STG4-RJ45/PN PUR 0,3M	4	0.3	6.5	1
192015.0060	S* STG4-RJ45/STG4-RJ45/PN PUR 0,6M	4	0.6	6.5	1
192015.0100	S* STG4-RJ45/STG4-RJ45/PN PUR 1,0M	4	1.0	6.5	1
192015.0150	S* STG4-RJ45/STG4-RJ45/PN PUR 1,5M	4	1.5	6.5	1
192015.0200	S* STG4-RJ45/STG4-RJ45/PN PUR 2,0M	4	2.0	6.5	1
192015.0500	S* STG8-RJ45/STG8-RJ45/PN 5,0M PUR	4	5.0	6.5	1
192015.1000	S* STG8-RJ45/STG8-RJ45/PN CAT5 10,0M PUR	4	10.0	6.5	1
192015.1500	S* STG8-RJ45/STG8-RJ45/PN 15,0M PUR	4	15.0	6.5	1
192015.2000	S* STG8-RJ45/STG8-RJ45/PN 20,0M PUR	4	20.0	6.5	1

Pin layout

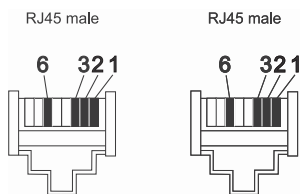

Circuit diagram

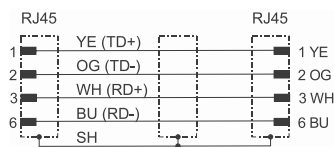

Actuator sensor interface - Network cables Ethernet

Male RJ45 straight to female RJ45 straight with PUR cable shielded 360°, Cat.5e
C-track compatible, halogen free



Construction

Number of conductors/cross-section (4×2×AWG26/19)
Number of conductors 8
Jacket material PUR
Jacket color green RAL 6018
Minimum bending radius fixed 6×D
Minimum bending radius moving 12×D

Operating voltage max. 50 V
Rated current 1.5 A
Form male 1 RJ45 male straight
Form male 2 RJ45 male straight
Degree of protection IP20
Color of the housing black
Temperature range connector -25 °C ... +85 °C
Temperature range fixed -40 °C ... +80 °C
Temperature range moving -30 °C ... +70 °C

50 V
1.5 A
RJ45 male straight
RJ45 male straight
IP20
black
-25 °C ... +85 °C
-40 °C ... +80 °C
-30 °C ... +70 °C

Technical data

Part No.	Type	Pole number	Cable length m	Cable diameter mm	PU (units)
192017.0030	S* STG8-RJ45/STG8-RJ45/ET PUR 0,3M	8	0.3	6.7	1
192017.0060	S* STG8-RJ45/STG8-RJ45/ET PUR 0,6M	8	0.6	6.7	1
192017.0100	S* STG8-RJ45/STG8-RJ45/ET PUR 1,0M	8	1.0	6.7	1
192017.0150	S* STG8-RJ45/STG8-RJ45/ET PUR 1,5M	8	1.5	6.7	1
192017.0200	S* STG8-RJ45/STG8-RJ45/ET PUR 2,0M	8	2.0	6.7	1
192017.0500	S* STG8-RJ45/STG8-RJ45/ET PUR 5,0M	8	5.0	6.7	1
192017.1000	S* STG8-RJ45/STG8-RJ45/ET PUR 10,0M	8	10.0	6.7	1
192017.1500	S* STG8-RJ45/STG8-RJ45/ET PUR 15,0M	8	15.0	6.7	1
192017.2000	S* STG8-RJ45/STG8-RJ45/ET PUR 20,0M	8	20.0	6.7	1

Pin layout

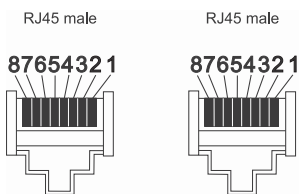

Circuit diagram

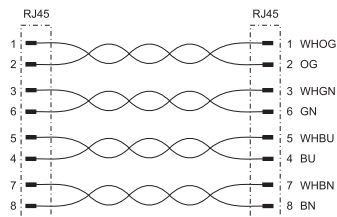

Actuator sensor interface - Network cables Ethernet

Male RJ45 straight to female RJ45 straight with PUR cable shielded 360°, Cat.6
C-track compatible, halogen free, flame-retardant



Construction

Number of conductors/cross-section (4×2×AWG26/19)StC
Number of conductors 8
Jacket material PUR
Jacket color green RAL 6018
Minimum bending radius fixed 4×D
Minimum bending radius moving 12×D

Operating voltage max. 50 V
Rated current 1.5 A
Form male 1 RJ45 male straight
Form male 2 RJ45 male straight
Degree of protection IP20
Color of the housing black
Temperature range connector -25 °C ... +85 °C
Temperature range fixed -40 °C ... +80 °C
Temperature range moving -30 °C ... +70 °C

Technical data

Part No.	Type	Pole number	Cable length m	Cable diameter mm	PU (units)
192766.0030	S* STG8-RJ45/STG8-RJ45/ET CAT6 PUR GN 0,3M	8	0.3	7.9	1
192766.0060	S* STG8-RJ45/STG8-RJ45/ET CAT6 PUR GN 0,6M	8	0.6	7.9	1
192766.0100	S* STG8-RJ45/STG8-RJ45/ET CAT6 PUR GN 1,0M	8	1.0	7.9	1
192766.0150	S* STG8-RJ45/STG8-RJ45/ET CAT6 PUR GN 1,5M	8	1.5	7.9	1
192766.0200	S* STG8-RJ45/STG8-RJ45/ET CAT6 PUR GN 2,0M	8	2.0	7.9	1
192766.0500	S* STG8-RJ45/STG8-RJ45/ET CAT6 PUR GN 5,0M	8	5.0	7.9	1
192766.1000	S* STG8-RJ45/STG8-RJ45/ET CAT6 PUR GN 10,0M	8	10.0	7.9	1
192766.1500	S* STG8-RJ45/STG8-RJ45/ET CAT6 PUR GN 15,0M	8	15.0	7.9	1
192766.2000	S* STG8-RJ45/STG8-RJ45/ET CAT6 PUR GN 20,0M	8	20.0	7.9	1

Pin layout

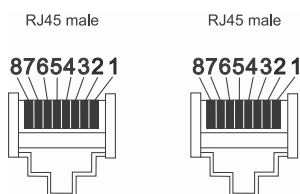

Circuit diagram

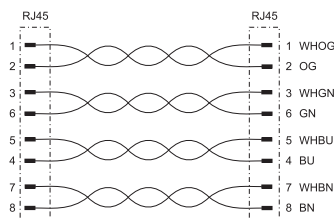

Actuator sensor interface - M8 – cables

Male M8 straight with PUR cable, open end
 Self-locking screw connection
 C-track compatible, halogen free



Properties

- Silicone free
- Free from paint wetting disruptive substances (LABS-free)
- Hydrolysis-resistant, microbe-resistant, and rot-resistant
- Resistance to acids, alkalines and watery solutions

Construction

Jacket material PUR
 Jacket color black
 Minimum bending radius moving 10×D

Technical data

Rated voltage U_N AC/DC 24 V
 Form male 1 M 8 male straight

Form male 2
 Degree of protection IP65/67/68
 Color of the housing black
 Mounting Breakaway torque 0.2 Nm
 Temperature range connector -25 °C ... +90 °C
 Temperature range fixed -40 °C ... +80 °C
 Temperature range moving -25 °C ... +80 °C
 UV-resistant according to DIN EN ISO 4892-2-A
 Certifications cULus Listed (E224249)
 HB

Flamability according to UL 94
Accessories

line end open
 IP65/67/68
 black
 Breakaway torque 0.2 Nm
 -25 °C ... +90 °C
 -40 °C ... +80 °C
 -25 °C ... +80 °C
 DIN EN ISO 4892-2-A
 cULus Listed (E224249)
 HB
Torque setting tool M 8: Part-No. 490090 | DM-SET M8 | PU: 1 unit

Part No.	Type	Pole number	Coding	Cable length m	Cable diameter mm	Operating voltage max. V	Rated current A	PU (units)
3 × 0.25 mm² (32 × 0.1)								
486020	S* STG3-M8 2M PUR	3	A	2.0	3.6	48	4	1
486050	S* STG3-M8 5M PUR	3	A	5.0	3.6	48	4	1
486100	S* STG3-M8 10M PUR	3	A	10.0	3.6	48	4	1
4 × 0.25 mm² (32 × 0.1)								
447020	S* STG4-M8 2M PUR	4	A	2.0	3.9	48	4	1
447050	S* STG4-M8 5M PUR	4	A	5.0	3.9	48	4	1
447100	S* STG4-M8 10M PUR	4	A	10.0	3.9	48	4	1

Pin layout

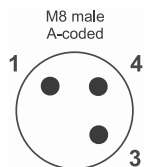

Circuit diagram

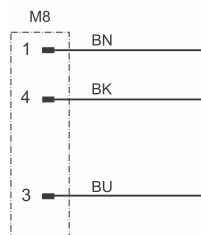

Pin layout

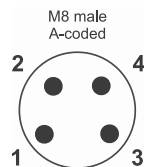

Circuit diagram

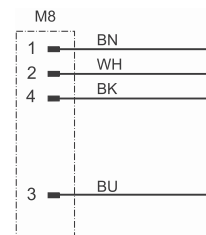

Actuator sensor interface - M8 – cables

Female M8 straight with PUR cable, open end
Self-locking screw connection
C-track compatible, halogen free



Properties

- Silicone free
- Free from paint wetting disruptive substances (LABS-free)
- Hydrolysis-resistant, microbe-resistant, and rot-resistant
- Resistance to acids, alkalines and watery solutions

Construction

Jacket material PUR
 Jacket color black
 Minimum bending radius moving 10×D

Technical data

Rated voltage U_N AC/DC 24 V
 Form male 1 M 8 female straight

Form male 2
 Degree of protection
 Color of the housing
 Mounting
 Temperature range connector
 Temperature range fixed
 Temperature range moving
 UV-resistant according to
 Certifications

Flamability according to UL 94
Accessories

line end open
 IP65/67/68
 black
 Breakaway torque 0.2 Nm
 -25 °C ... +90 °C
 -40 °C ... +80 °C
 -25 °C ... +80 °C
 DIN EN ISO 4892-2-A

cULus Listed (E224249)
 HB
Torque setting tool M 8: Part-No.
 490090 | DM-SET M8 | PU: 1 unit

Part No.	Type	Pole number	Coding	Cable length m	Cable diameter mm	Operating voltage max. V	Rated current A	PU (units)
3 × 0.25 mm² (32 × 0.1)								
481020	S* KUG3-M8 2M PUR	3	A	2.0	3.6	48	4	1
481050	S* KUG3-M8 5M PUR	3	A	5.0	3.6	48	4	1
481100	S* KUG3-M8 10M PUR	3	A	10.0	3.6	48	4	1
4 × 0.25 mm² (32 × 0.1)								
415020	S* KUG4-M8 2,0M PUR	4	A	2.0	3.9	48	4	1
415050	S* KUG4-M8 5,0M PUR	4	A	5.0	3.9	48	4	1
415100	S* KUG4-M8 10,0M PUR	4	A	10.0	3.9	48	4	1

Pin layout

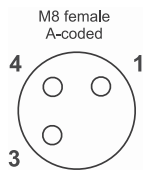

Circuit diagram

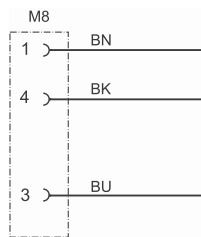

Pin layout

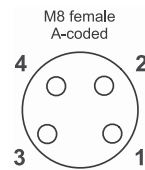

Circuit diagram

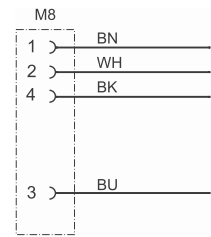

Actuator sensor interface - M8 – cables

Female M8 straight with PUR cable, shielded 360°, open end
 Self-locking screw connection
 C-track compatible, halogen free



Properties

- Silicone free
- Free from paint wetting disruptive substances (LABS-free)
- Hydrolysis-resistant, microbe-resistant, and rot-resistant
- Resistance to acids, alkalines and watery solutions

Construction

Jacket material PUR
 Jacket color black
 Minimum bending radius moving 10×D

Technical data

Rated voltage U_N AC/DC 24 V
 Form male 1 M 8 female straight

Form male 2
 Degree of protection IP65/67
 Color of the housing black
 Mounting Temperature range connector
 Temperature range fixed -25 °C ... +80 °C
 Temperature range moving -25 °C ... +80 °C
 UV-resistant according to Certifications

Flamability according to UL 94
Accessories

line end open
 IP65/67
 black
 Breakaway torque 0.2 Nm
 -25 °C ... +90 °C
 -40 °C ... +80 °C
 -25 °C ... +80 °C
 DIN EN ISO 4892-2-A

cULus Listed (E224249)
 HB
Torque setting tool M 8: Part-No. 490090 | DM-SET M8 | PU: 1 unit

Part No.	Type	Pole number	Coding	Cable length m	Cable diameter mm	Operating voltage max. V	Rated current A	PU (units)
3 × 0.25 mm² (32 × 0.1)								
458302	S* KUG3-M8(C) 2M PUR	3	A	2.0	4.3	48	4	1
458305	S* KUG3-M8(C) 5M PUR	3	A	5.0	4.3	48	4	1
458310	S* KUG3-M8(C) 10M PUR	3	A	10.0	4.3	48	4	1
4 × 0.25 mm² (32 × 0.1)								
458402	S* KUG4-M8(C) 2,0M PUR	4	A	2.0	4.7	48	4	1
458405	S* KUG4-M8(C) 5,0M PUR	4	A	5.0	4.7	48	4	1
458410	S* KUG4-M8(C) 10M PUR	4	A	10.0	4.7	48	4	1

Pin layout

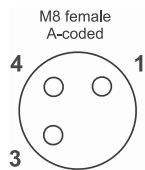

Circuit diagram

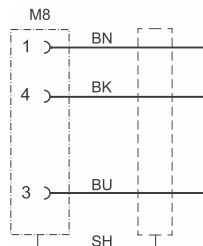

Pin layout

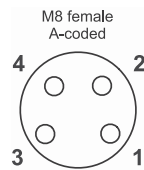

Circuit diagram

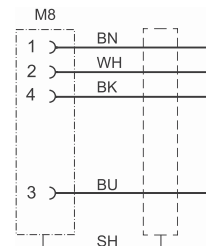

Actuator sensor interface - M8 – cables

Female M8 angled with PUR cable, open end
Self-locking screw connection
C-track compatible, halogen free



Properties

- Silicone free
- Free from paint wetting disruptive substances (LABS-free)
- Hydrolysis-resistant, microbe-resistant, and rot-resistant
- Resistance to acids, alkalines and watery solutions

Construction

Jacket material PUR
 Jacket color black
 Minimum bending radius moving 10×D

Technical data

Rated voltage U_N AC/DC 24 V
 Form male 1 M 8 female angle connector

Form male 2
 Degree of protection
 Color of the housing
 Mounting
 Temperature range connector
 Temperature range fixed
 Temperature range moving
 UV-resistant according to
 Certifications

Flamability according to UL 94
Accessories

line end open
 IP65/67/68
 black
 Breakaway torque 0.2 Nm
 -25 °C ... +90 °C
 -40 °C ... +80 °C
 -25 °C ... +80 °C
 DIN EN ISO 4892-2-A

cULus Listed (E224249)
 HB
Torque setting tool M 8: Part-No.
 490090 | DM-SET M8 | PU: 1 unit

Part No.	Type	Pole number	Coding	Cable length m	Cable diameter mm	Operating voltage max. V	Rated current A	PU (units)
3 × 0.25 mm² (32 × 0.1)								
474020	S* KUW3-M8 2M PUR	3	A	2.0	3.6	48	4	1
474050	S* KUW3-M8 5M PUR	3	A	5.0	3.6	48	4	1
474100	S* KUW3-M8 10M PUR	3	A	10.0	3.6	48	4	1
4 × 0.25 mm² (32 × 0.1)								
416020	S* KUW4-M8 2,0M PUR	4	A	2.0	3.9	48	4	1
416050	S* KUW4-M8 5,0M PUR	4	A	5.0	3.9	48	4	1
416100	S* KUW4-M8 10,0M PUR	4	A	10.0	3.9	48	4	1

Pin layout

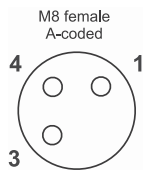

Circuit diagram

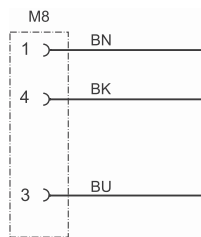

Pin layout

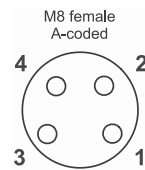

Circuit diagram

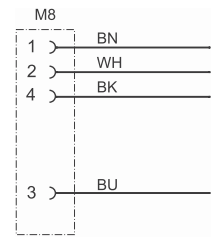

Actuator sensor interface - M8 / M8 - cables

Male M8 straight to female M8 straight with PUR cable
 Self-locking screw connection
 C-track compatible, halogen free



Properties

- Silicone free
- Free from paint wetting disruptive substances (LABS-free)
- Hydrolysis-resistant, microbe-resistant, and rot-resistant
- Resistance to acids, alkalines and watery solutions

Construction

Jacket material PUR
 Jacket color black
 Minimum bending radius moving 10×D

Technical data

Rated voltage U_N AC/DC 24 V
 Form male 1 M 8 male straight

Form male 2
 Degree of protection
 Color of the housing
 Mounting
 Temperature range connector
 Temperature range fixed
 Temperature range moving
 UV-resistant according to
 Certifications

Flamability according to UL 94
Accessories

M 8 female straight
 IP65/67/68
 black
 Breakaway torque 0.2 Nm
 -25 °C ... +90 °C
 -40 °C ... +80 °C
 -25 °C ... +80 °C
 DIN EN ISO 4892-2-A

cULus Listed (E224249)
 HB
Torque setting tool M 8: Part-No.
 490090 | DM-SET M8 | PU: 1 unit

Part No.	Type	Pole number	Coding	Cable length m	Cable diameter mm	Operating voltage max. V	Rated current A	PU (units)
3 × 0.25 mm² (32 × 0.1)								
487003	S* STG3-M8/KUG3-M8 0,3M PUR	3	A	0.3	3.6	48	4	1
487006	S* STG3-M8/KUG3-M8 0,6M PUR	3	A	0.6	3.6	48	4	1
487010	S* STG3-M8/KUG3-M8 1,0M PUR	3	A	1.0	3.6	48	4	1
487015	S* STG3-M8/KUG3-M8 1,5M PUR	3	A	1.5	3.6	48	4	1
487020	S* STG3-M8/KUG3-M8 2,0M PUR	3	A	2.0	3.6	48	4	1
487050	S* STG3-M8/KUG3-M8 5,0M PUR	3	A	5.0	3.6	48	4	1

PIN assignment

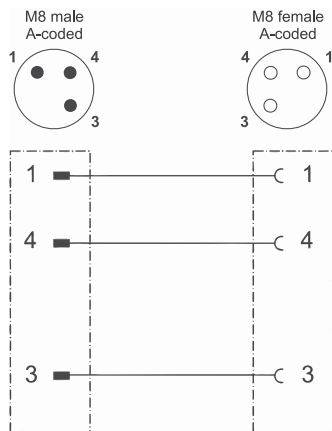

Actuator sensor interface - M8 / M8 - cables

Male M8 straight to female M8 straight with PUR cable
Self-locking screw connection
C-track compatible, halogen free



Properties

- Silicone free
- Free from paint wetting disruptive substances (LABS-free)
- Hydrolysis-resistant, microbe-resistant, and rot-resistant
- Resistance to acids, alkalines and watery solutions

Construction

Jacket material PUR
 Jacket color black
 Minimum bending radius moving 10×D

Technical data

Rated voltage U_N AC/DC 24 V
 Form male 1 M 8 male straight

Form male 2
 Degree of protection
 Color of the housing
 Mounting
 Temperature range connector
 Temperature range fixed
 Temperature range moving
 UV-resistant according to Certifications

Flamability according to UL 94
Accessories

M 8 female straight
 IP65/67/68
 black
 Breakaway torque 0.2 Nm
 -25 °C ... +90 °C
 -40 °C ... +80 °C
 -25 °C ... +80 °C
 DIN EN ISO 4892-2-A

cULus Listed (E224249)
 HB
Torque setting tool M 8: Part-No. 490090 | DM-SET M8 | PU: 1 unit

Part No.	Type	Pole number	Coding	Cable length m	Cable diameter mm	Operating voltage max. V	Rated current A	PU (units)
4 x 0.25 mm² (32 x 0.1)								
410003	S* STG4-M8/KUG4-M8 0,3m PUR	4	A	0.3	3.9	48	4	1
410006	S* STG4-M8/KUG4-M8 0,6m PUR	4	A	0.6	3.9	48	4	1
410010	S* STG4-M8/KUG4-M8 1,0m PUR	4	A	1.0	3.9	48	4	1
410015	S* STG4-M8/KUG4-M8 1,5m PUR	4	A	1.5	3.9	48	4	1
410020	S* STG4-M8/KUG4-M8 2,0m PUR	4	A	2.0	3.9	48	4	1
410050	S* STG4-M8/KUG4-M8 5,0m PUR	4	A	5.0	3.9	48	4	1

PIN assignment

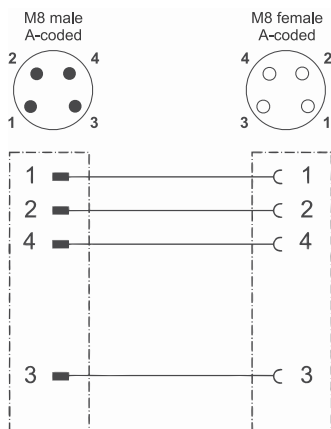

Actuator sensor interface - M8 / M8 - cables

Male M8 straight to female M8 angled with PUR cable

Self-locking screw connection

C-track compatible, halogen free



Properties

- Silicone free
- Free from paint wetting disruptive substances (LABS-free)
- Hydrolysis-resistant, microbe-resistant, and rot-resistant
- Resistance to acids, alkalines and watery solutions

Construction

Jacket material PUR
 Jacket color black
 Minimum bending radius moving 10×D

Technical data

Rated voltage U_N AC/DC 24 V
 Form male 1 M 8 male straight

Form male 2
 Degree of protection
 Color of the housing
 Mounting
 Temperature range connector
 Temperature range fixed
 Temperature range moving
 UV-resistant according to
 Certifications

Flamability according to UL 94
Accessories

M 8 female angle connector
 IP65/67/68
 black
 Breakaway torque 0.2 Nm
 -25 °C ... +90 °C
 -40 °C ... +80 °C
 -25 °C ... +80 °C
 DIN EN ISO 4892-2-A

cULus Listed (E224249)
 HB
Torque setting tool M 8: Part-No.
 490090 | DM-SET M8 | PU: 1 unit

Part No.	Type	Pole number	Coding	Cable length m	Cable diameter mm	Operating voltage max. V	Rated current A	PU (units)
3 × 0.25 mm² (32 × 0.1)								
488003	S* STG3-M8/ KUW3-M8 0,3M PUR	3	A	0.3	3.6	48	4	1
488006	S* STG3-M8/ KUW3-M8 0,6M PUR	3	A	0.6	3.6	48	4	1
488010	S* STG3-M8/ KUW3-M8 1,0M PUR	3	A	1.0	3.6	48	4	1
488015	S* STG3-M8/ KUW3-M8 1,5M PUR	3	A	1.5	3.6	48	4	1
488020	S* STG3-M8/ KUW3-M8 2,0M PUR	3	A	2.0	3.6	48	4	1
488050	S* STG3-M8/ KUW3-M8 5,0M PUR	3	A	5.0	3.6	48	4	1

PIN assignment

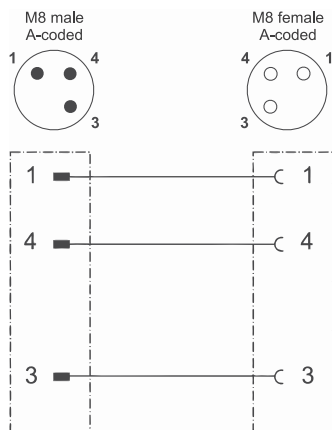

Actuator sensor interface - M12 - cables

Male M12 straight with PUR cable, open end
Self-locking screw connection
C-track compatible, halogen free



Properties

- Silicone free
- Free from paint wetting disruptive substances (LABS-free)
- Hydrolysis-resistant, microbe-resistant, and rot-resistant
- Resistance to acids, alkalines and watery solutions

Construction

Jacket material PUR
 Jacket color black
 Minimum bending radius moving 10xD

Technical data

Rated voltage U_N AC/DC 24 V
 Form male 1 M 12 male straight

Form male 2
 Degree of protection
 Color of the housing
 Mounting
 Temperature range connector
 Temperature range fixed
 Temperature range moving
 UV-resistant according to
 Certifications

Flamability according to UL 94
Accessories

line end open
 IP65/67/68
 black
 Breakaway torque 0.4 Nm
 -25 °C ... +90 °C
 -40 °C ... +80 °C
 -25 °C ... +80 °C
 DIN EN ISO 4892-2-A

cULus Listed (E224249)
 HB
Torque setting tool M 12: Part-No.
 490091 | DM-SET M12 | PU: 1 unit

Part No.	Type	Pole number	Coding	Cable length m	Cable diameter mm	Operating voltage max. V	Rated current A	PU (units)
3 x 0.34 mm² (42 x 0.1)								
471020	S* STG3-M12 2M PUR	3	A	2.0	3.8	250	4	1
471050	S* STG3-M12 5M PUR	3	A	5.0	3.8	250	4	1
471100	S* STG3-M12 10M PUR	3	A	10.0	3.8	250	4	1
4 x 0.34 mm² (42 x 0.1)								
472020	S* STG4-M12 2M PUR	4	A	2.0	4.1	250	4	1
472050	S* STG4-M12 5M PUR	4	A	5.0	4.1	250	4	1
472100	S* STG4-M12 10M PUR	4	A	10.0	4.1	250	4	1

Pin layout

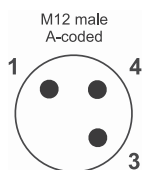

PIN assignment

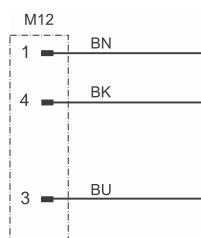

Pin layout

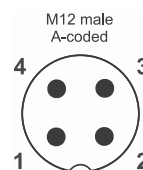

PIN assignment

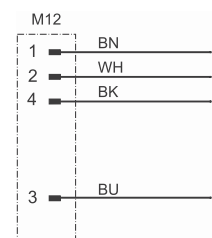

Actuator sensor interface - M12 - cables

Male M12 straight with PUR cable, open end
Self-locking screw connection
C-track compatible, halogen free



Construction
 Jacket material
 Jacket color
 Minimum bending radius moving

PUR
 black
 10×D

Technical data
 Rated voltage U_N
 Form male 1
 Form male 2
 Degree of protection
 Color of the housing

AC/DC 24 V
 M 12 male straight
 line end open
 IP65/67/68
 black

Mounting
 Temperature range connector
 Temperature range fixed
 Temperature range moving
 UV-resistant according to
 Certifications

Breakaway torque 0.4 Nm
 -25 °C ... +90 °C
 -40 °C ... +80 °C
 -25 °C ... +80 °C
 DIN EN ISO 4892-2-A

Flamability according to UL 94
Accessories

cULus Listed (E224249)
 HB
Torque setting tool M 12: Part-No.
 490091 | DM-SET M12 | PU: 1 unit

Part No.	Type	Pole number	Coding	Cable length m	Cable diameter mm	Operating voltage max. V	Rated current A	PU (units)
5 × 0.34 mm² (42 × 0.1)								
473020	S* STG5-M12 2M PUR	5	A	2.0	4.5	48	4	1
473050	S* STG5-M12 5M PUR	5	A	5.0	4.5	48	4	1
473100	S* STG5-M12 10M PUR	5	A	10.0	4.5	48	4	1
8 × 0.25 mm² (32 × 0.1)								
482020	S* STG8-M12 2M PUR	8	A	2.0	5.9	30	2	1
482050	S* STG8-M12 5M PUR	8	A	5.0	5.9	30	2	1
482100	S* STG8-M12 10M PUR	8	A	10.0	5.9	30	2	1

Pin layout

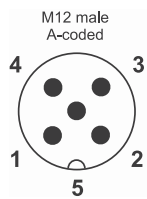

PIN assignment

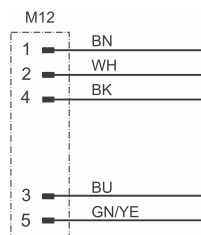

Pin layout

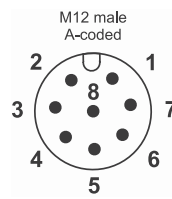

PIN assignment

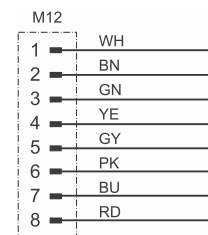

Actuator sensor interface - M12 - cables

Male M12 straight with PUR cable, shielded 360°, open end
Self-locking screw connection
C-track compatible, halogen free



Properties

- Silicone free
- Free from paint wetting disruptive substances (LABS-free)
- Hydrolysis-resistant, microbe-resistant, and rot-resistant
- Resistance to acids, alkalines and watery solutions

Construction

Jacket material PUR
 Jacket color black
 Minimum bending radius moving 10×D

Technical data

Rated voltage U_N AC/DC 24 V
 Form male 1 M 12 male straight

Form male 2
 Degree of protection IP65/67
 Color of the housing black
 Mounting Breakaway torque 0.4 Nm
 Temperature range connector -25 °C ... +90 °C
 Temperature range fixed -40 °C ... +80 °C
 Temperature range moving -25 °C ... +80 °C
 UV-resistant according to Certifications

Flamability according to UL 94
Accessories

line end open
 IP65/67
 black
 Breakaway torque 0.4 Nm
 -25 °C ... +90 °C
 -40 °C ... +80 °C
 -25 °C ... +80 °C
 DIN EN ISO 4892-2-A

cULus Listed (E224249)
 HB

Torque setting tool M 12: Part-No. 490091 | DM-SET M12 | PU: 1 unit

Part No.	Type	Pole number	Coding	Cable length m	Cable diameter mm	Operating voltage max. V	Rated current A	PU (units)
5 × 0.34 mm² (42 × 0.1)								
456202	S* STG5-M12(C)2m PUR	5	A	2.0	5.3	60	4	1
456205	S* STG5-M12(C)5m PUR	5	A	5.0	5.3	60	4	1
456210	S* STG5-M12(C)10m PUR	5	A	10.0	5.3	60	4	1
8 × 0.25 mm² (32 × 0.1)								
458702	S* STG8-M12(C)2M PUR	8	A	2.0	5.9	30	2	1
458705	S* STG8-M12(C)5M PUR	8	A	5.0	5.9	30	2	1
458710	S* STG8-M12(C)10M PUR	8	A	10.0	5.9	30	2	1

Pin layout

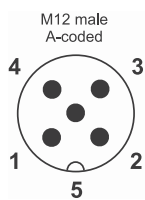

Circuit diagram

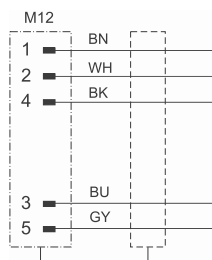

Pin layout

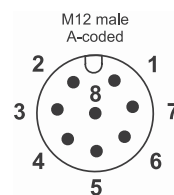

Circuit diagram

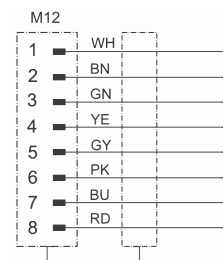

Actuator sensor interface - M12 - cables

Female M12 straight with PUR cable, open end
 Self-locking screw connection
 C-track compatible, halogen free

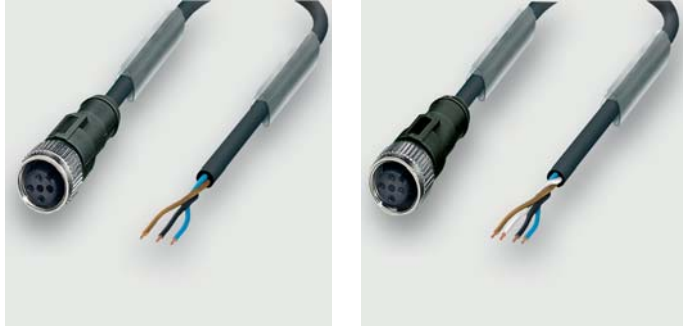

Properties

- Silicone free
- Free from paint wetting disruptive substances (LABS-free)
- Hydrolysis-resistant, microbe-resistant, and rot-resistant
- Resistance to acids, alkalines and watery solutions

Construction

Jacket material PUR
 Jacket color black
 Minimum bending radius moving 10xD

Technical data

Rated voltage U_N AC/DC 24 V
 Form male 1 M 12 female straight

Form male 2
 Degree of protection
 Color of the housing
 Mounting
 Temperature range connector
 Temperature range fixed
 Temperature range moving
 UV-resistant according to
 Certifications

Flamability according to UL 94
Accessories

line end open
 IP65/67/68
 black
 Breakaway torque 0.4 Nm
 -25 °C ... +90 °C
 -40 °C ... +80 °C
 -25 °C ... +80 °C
 DIN EN ISO 4892-2-A

cULus Listed (E224249)
 HB
Torque setting tool M 12: Part-No.
 490091 | DM-SET M12 | PU: 1 unit

Part No.	Type	Pole number	Coding	Cable length m	Cable diameter mm	Operating voltage max. V	Rated current A	PU (units)
3 x 0.34 mm² (42 x 0.1)								
465020	A* KUG3-M12 2M PUR	3	A	2.0	3.8	250	4	1
465050	S* KUG3-M12 5M PUR	3	A	5.0	3.8	250	4	1
465100	A* KUG3-M12 10M PUR	3	A	10.0	3.8	250	4	1
4 x 0.34 mm² (42 x 0.1)								
466020	S* KUG4-M12 2M PUR	4	A	2.0	4.1	250	4	1
466050	S* KUG4-M12 5M PUR	4	A	5.0	4.1	250	4	1
466100	S* KUG4-M12 10M PUR	4	A	10.0	4.1	250	4	1

Pin layout

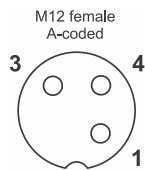

PIN assignment

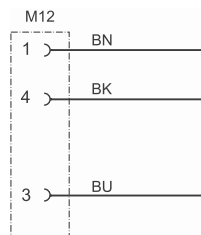

Pin layout

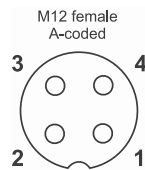

PIN assignment

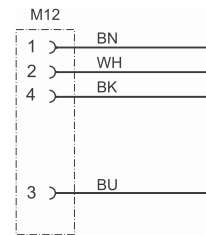

Actuator sensor interface - M12 - cables

Female M12 straight with PUR cable, open end
Self-locking screw connection
C-track compatible, halogen free



Properties

- Silicone free
- Free from paint wetting disruptive substances (LABS-free)
- Hydrolysis-resistant, microbe-resistant, and rot-resistant
- Resistance to acids, alkalines and watery solutions

Construction

Jacket material PUR
 Jacket color black
 Minimum bending radius moving 10×D

Technical data

Rated voltage U_N AC/DC 24 V
 Form male 1 M 12 female straight

Form male 2
 Degree of protection
 Color of the housing
 Mounting
 Temperature range connector
 Temperature range fixed
 Temperature range moving
 UV-resistant according to
 Certifications

Flamability according to UL 94
Accessories

line end open
 IP65/67/68
 black
 Breakaway torque 0.4 Nm
 -25 °C ... +90 °C
 -40 °C ... +80 °C
 -25 °C ... +80 °C
 DIN EN ISO 4892-2-A

cULus Listed (E224249)
 HB
Torque setting tool M 12: Part-No.
 490091 | DM-SET M12 | PU: 1 unit

Part No.	Type	Pole number	Coding	Cable length m	Cable diameter mm	Operating voltage max. V	Rated current A	PU (units)
5 × 0.34 mm² (42 × 0.1)								
477020	S* KUG5-M12 2M PUR	5	A	2.0	4.5	60	4	1
477050	S* KUG5-M12 5M PUR	5	A	5.0	4.5	60	4	1
477100	S* KUG5-M12 10M PUR	5	A	10.0	4.5	60	4	1
8 × 0.25 mm² (32 × 0.1)								
478020	S* KUG8-M12 2M PUR	8	A	2.0	5.9	30	2	1
478050	S* KUG8-M12 5M PUR	8	A	5.0	5.9	30	2	1
478100	S* KUG8-M12 10M PUR	8	A	10.0	5.9	30	2	1

Pin layout

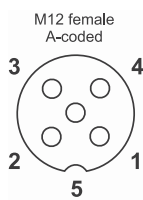

Circuit diagram

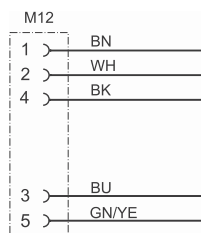

Pin layout

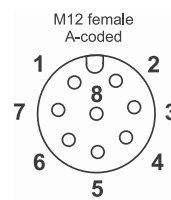

Circuit diagram

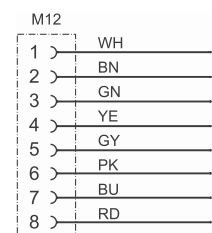

Actuator sensor interface - M12 - cables

Female M12 straight with PUR cable, shielded 360°, open end
 Self-locking screw connection
 C-track compatible, halogen free



Properties

- Silicone free
- Free from paint wetting disruptive substances (LABS-free)
- Hydrolysis-resistant, microbe-resistant, and rot-resistant
- Resistance to acids, alkalines and watery solutions

Construction

Jacket material PUR
 Jacket color black
 Minimum bending radius moving 10×D

Technical data

Rated voltage U_N AC/DC 24 V
 Form male 1 M 12 female straight

Form male 2
 Degree of protection
 Color of the housing
 Mounting
 Temperature range connector
 Temperature range fixed
 Temperature range moving
 UV-resistant according to
 Certifications

Flamability according to UL 94
Accessories

line end open
 IP65/67
 black
 Breakaway torque 0.4 Nm
 -25 °C ... +90 °C
 -40 °C ... +80 °C
 -25 °C ... +80 °C
 DIN EN ISO 4892-2-A

cULus Listed (E224249)
 HB
Torque setting tool M 12: Part-No.
 490091 | DM-SET M12 | PU: 1 unit

Part No.	Type	Pole number	Coding	Cable length m	Cable diameter mm	Operating voltage max. V	Rated current A	PU (units)
4 × 0.34 mm² (42 × 0.1)								
456402	S* KUG4-M12(C) 2m PUR	4	A	2.0	4.9	250	4	1
456405	S* KUG4-M12(C) 5m PUR	4	A	5.0	4.9	250	4	1
456410	S* KUG4-M12(C) 10m PUR	4	A	10.0	4.9	250	4	1

Pin layout

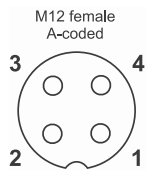

PIN assignment

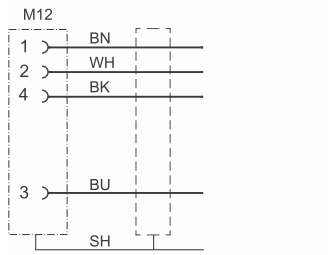

Actuator sensor interface - M12 - cables

Female M12 straight with PUR cable, shielded 360°, open end
Self-locking screw connection
C-track compatible, halogen free



Properties

- Silicone free
- Free from paint wetting disruptive substances (LABS-free)
- Hydrolysis-resistant, microbe-resistant, and rot-resistant
- Resistance to acids, alkalines and watery solutions

Construction

Jacket material PUR
 Jacket color black
 Minimum bending radius moving 10×D

Technical data

Rated voltage U_N AC/DC 24 V
 Form male 1 M 12 female straight

Form male 2
 Degree of protection
 Color of the housing
 Mounting
 Temperature range connector
 Temperature range fixed
 Temperature range moving
 UV-resistant according to
 Certifications

Flamability according to UL 94
Accessories

line end open
 IP65/67
 black
 Breakaway torque 0.4 Nm
 -25 °C ... +90 °C
 -40 °C ... +80 °C
 -25 °C ... +80 °C
 DIN EN ISO 4892-2-A

cULus Listed (E224249)
 HB
Torque setting tool M 12: Part-No.
 490091 | DM-SET M12 | PU: 1 unit

Part No.	Type	Pole number	Coding	Cable length m	Cable diameter mm	Operating voltage max. V	Rated current A	PU (units)
5 × 0.34 mm² (42 × 0.1)								
456502	S* KUG5-M12(C) 2m PUR	5	A	2.0	5.3	60	4	1
456505	S* KUG5-M12(C) 5m PUR	5	A	5.0	5.3	60	4	1
456510	S* KUG5-M12(C) 10m PUR	5	A	10.0	5.3	60	4	1
8 × 0.25 mm² (32 × 0.1)								
458802	S* KUG8-M12(C) 2M PUR	8	A	2.0	5.9	30	2	1
458805	S* KUG8-M12(C) 5M PUR	8	A	5.0	5.9	30	2	1
458810	S* KUG8-M12(C) 10M PUR	8	A	10.0	5.9	30	2	1

Pin layout

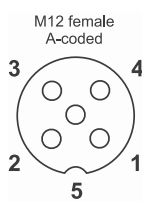

Circuit diagram

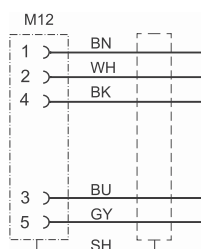

Pin layout

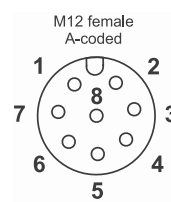

Circuit diagram

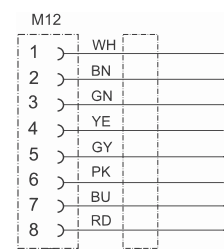

Actuator sensor interface - M12 - cables

Female M12 angled with PUR cable, open end
 Self-locking screw connection
 C-track compatible, halogen free



Properties

- Silicone free
- Free from paint wetting disruptive substances (LABS-free)
- Hydrolysis-resistant, microbe-resistant, and rot-resistant
- Resistance to acids, alkalines and watery solutions

Construction

Jacket material PUR
 Jacket color black
 Minimum bending radius moving 10xD

Technical data

Rated voltage U_N AC/DC 24 V
 Form male 1 M 12 female angle connector

Form male 2
 Degree of protection IP65/67/68
 Color of the housing black
 Mounting Breakaway torque 0.4 Nm
 Temperature range connector -25 °C ... +90 °C
 Temperature range fixed -40 °C ... +80 °C
 Temperature range moving -25 °C ... +80 °C
 UV-resistant according to DIN EN ISO 4892-2-A
 Certifications cULus Listed (E224249)
 HB

Flamability according to UL 94
Accessories

line end open
 IP65/67/68
 black
 Breakaway torque 0.4 Nm
 -25 °C ... +90 °C
 -40 °C ... +80 °C
 -25 °C ... +80 °C
 DIN EN ISO 4892-2-A
 cULus Listed (E224249)
 HB
Torque setting tool M 12: Part-No. 490091 | DM-SET M12 | PU: 1 unit

Part No.	Type	Pole number	Coding	Cable length m	Cable diameter mm	Operating voltage max. V	Rated current A	PU (units)
3 x 0.34 mm² (42 x 0.1)								
462020	S* KUW3-M12 2M PUR	3	A	2.0	3.8	250	4	1
462050	S* KUW3-M12 5M PUR	3	A	5.0	3.8	250	4	1
462100	S* KUW3-M12 10M PUR	3	A	10.0	3.8	250	4	1
4 x 0.34 mm² (42 x 0.1)								
464020	S* KUW4-M12 2M PUR	4	A	2.0	4.1	250	4	1
464050	S* KUW4-M12 5M PUR	4	A	5.0	4.1	250	4	1
464100	S* KUW4-M12 10M PUR	4	A	10.0	4.1	250	4	1

Pin layout

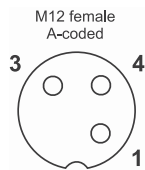

PIN assignment

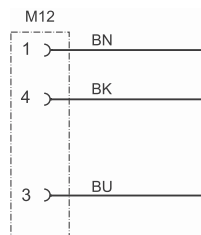

Pin layout

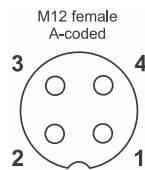

PIN assignment

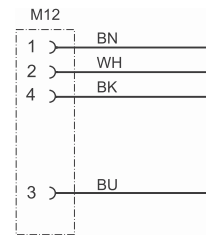

Actuator sensor interface - M12 - cables

Female M12 angled with PUR cable, open end
Self-locking screw connection
C-track compatible, halogen free



Properties

- Silicone free
- Free from paint wetting disruptive substances (LABS-free)
- Hydrolysis-resistant, microbe-resistant, and rot-resistant
- Resistance to acids, alkalines and watery solutions

Construction

Jacket material PUR
 Jacket color black
 Minimum bending radius moving 10×D

Technical data

Rated voltage U_N AC/DC 24 V
 Form male 1 M 12 female angle connector

Form male 2
 Degree of protection
 Color of the housing
 Mounting
 Temperature range connector
 Temperature range fixed
 Temperature range moving
 UV-resistant according to
 Certifications

Flamability according to UL 94
Accessories

line end open
 IP65/67/68
 black
 Breakaway torque 0.4 Nm
 -25 °C ... +90 °C
 -40 °C ... +80 °C
 -25 °C ... +80 °C
 DIN EN ISO 4892-2-A

cULus Listed (E224249)
 HB
Torque setting tool M 12: Part-No.
 490091 | DM-SET M12 | PU: 1 unit

Part No.	Type	Pole number	Coding	Cable length m	Cable diameter mm	Operating voltage max. V	Rated current A	PU (units)
5 × 0.34 mm² (42 × 0.1)								
443020	S* KUW5-M12 2M PUR	5	A	2.0	4.5	60	4	1
443050	S* KUW5-M12 5M PUR	5	A	5.0	4.5	60	4	1
443100	S* KUW5-M12 10M PUR	5	A	10.0	4.5	60	4	1
8 × 0.25 mm² (32 × 0.1)								
479020	S* KUW8-M12 2M PUR	8	A	2.0	5.9	30	2	1
479050	S* KUW8-M12 5M PUR	8	A	5.0	5.9	30	2	1
479100	S* KUW8-M12 10M PUR	8	A	10.0	5.9	30	2	1

Pin layout

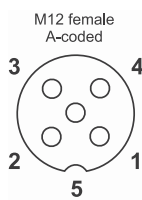

Circuit diagram

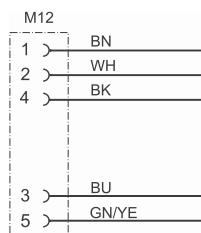

Pin layout

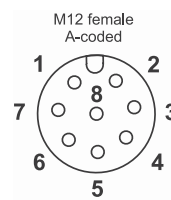

Circuit diagram

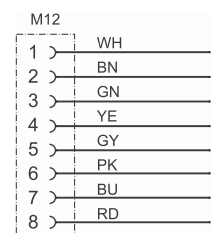

Actuator sensor interface - M12 - cables

Female M12 angled with PUR cable, shielded 360°, open end
 Self-locking screw connection
 C-track compatible, halogen free



Properties

- Silicone free
- Free from paint wetting disruptive substances (LABS-free)
- Hydrolysis-resistant, microbe-resistant, and rot-resistant
- Resistance to acids, alkalines and watery solutions

Construction

Jacket material PUR
 Jacket color black
 Minimum bending radius moving 10×D

Technical data

Rated voltage U_N AC/DC 24 V
 Form male 1 M 12 female angle connector

Form male 2
 Degree of protection IP65/67
 Color of the housing black
 Mounting Breakaway torque 0.4 Nm
 Temperature range connector -25 °C ... +90 °C
 Temperature range fixed -40 °C ... +80 °C
 Temperature range moving -25 °C ... +80 °C
 UV-resistant according to DIN EN ISO 4892-2-A
 Certifications cULus Listed (E224249)
 HB

Flamability according to UL 94
Accessories

line end open
 IP65/67
 black
 Breakaway torque 0.4 Nm
 -25 °C ... +90 °C
 -40 °C ... +80 °C
 -25 °C ... +80 °C
 DIN EN ISO 4892-2-A
 cULus Listed (E224249)
 HB
Torque setting tool M 12: Part-No. 490091 | DM-SET M12 | PU: 1 unit

Part No.	Type	Pole number	Coding	Cable length m	Cable diameter mm	Operating voltage max. V	Rated current A	PU (units)
4 × 0.34mm² (42 × 0.1)								
456702	S* KUW4-M12(C) 2m PUR	4	A	2.0	4.9	250	4	1
456705	S* KUW4-M12(C) 5m PUR	4	A	5.0	4.9	250	4	1
456710	S* KUW4-M12(C) 10m PUR	4	A	10.0	4.9	250	4	1

Pin layout

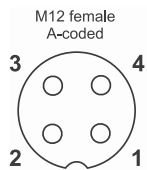

PIN assignment

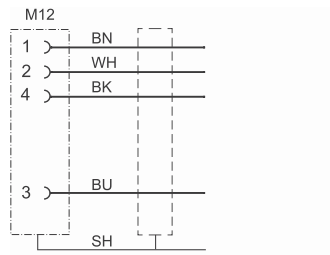

Actuator sensor interface - M12 - cables

Female M12 angled with PUR cable, shielded 360°, open end
Self-locking screw connection
C-track compatible, halogen free



Properties

- Silicone free
- Free from paint wetting disruptive substances (LABS-free)
- Hydrolysis-resistant, microbe-resistant, and rot-resistant
- Resistance to acids, alkalines and watery solutions

Construction

Jacket material PUR
 Jacket color black
 Minimum bending radius moving 10xD

Technical data

Rated voltage U_N AC/DC 24 V
 Form male 1 M 12 female angle connector

Form male 2
 Degree of protection
 Color of the housing
 Mounting
 Temperature range connector
 Temperature range fixed
 Temperature range moving
 UV-resistant according to
 Certifications

Flamability according to UL 94
Accessories

line end open
 IP65/67
 black
 Breakaway torque 0.4 Nm
 -25 °C ... +90 °C
 -40 °C ... +80 °C
 -25 °C ... +80 °C
 DIN EN ISO 4892-2-A

cULus Listed (E224249)
 HB
Torque setting tool M 12: Part-No.
 490091 | DM-SET M12 | PU: 1 unit

Part No.	Type	Pole number	Coding	Cable length m	Cable diameter mm	Operating voltage max. V	Rated current A	PU (units)
5 x 0.34 mm² (42 x 0.1)								
456802	S* KUW5-M12(C) 2m PUR	5	A	2.0	5.3	60	4	1
456805	S* KUW5-M12(C) 5m PUR	5	A	5.0	5.3	60	4	1
456810	S* KUW5-M12(C) 10m PUR	5	A	10.0	5.3	60	4	1
8 x 0.25 mm² (32 x 0.1)								
458902	S* KUW8-M12(C) 2M PUR	8	A	2.0	5.9	30	2	1
458905	S* KUW8-M12(C) 5M PUR	8	A	5.0	5.9	30	2	1
458910	S* KUW8-M12(C) 10M PUR	8	A	10.0	5.9	30	2	1

Pin layout

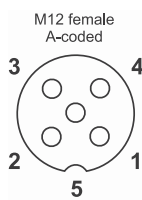

Circuit diagram

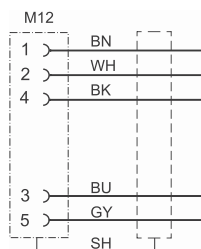

Pin layout

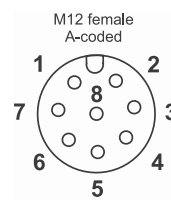

Circuit diagram

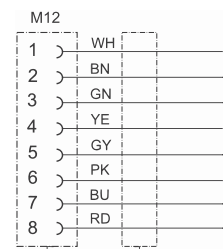

Actuator sensor interface - M12 - cables

Female M12 angled, with LEDs and PUR cable, open end
 Self-locking screw connection
 C-track compatible, halogen free



Properties

- Silicone free
- Free from paint wetting disruptive substances (LABS-free)
- Hydrolysis-resistant, microbe-resistant, and rot-resistant
- Resistance to acids, alkalines and watery solutions

Construction

Jacket material PUR
 Jacket color black
 Minimum bending radius moving 10xD

Technical data

Rated voltage U_N DC 24 V
 Form male 1 M 12 female angle connector

Form male 2
 Degree of protection
 Color of the housing
 Mounting
 Temperature range connector
 Temperature range fixed
 Temperature range moving
 UV-resistant according to
 Certifications

Flamability according to UL 94
Accessories

line end open
 IP65/67/68
 black
 Torque 0.4 Nm
 -25 °C ... +90 °C
 -40 °C ... +80 °C
 -25 °C ... +80 °C
 DIN EN ISO 4892-2-A

cULus Listed (E224249)
 HB
Torque setting tool M 12: Part-No.
 490091 | DM-SET M12 | PU: 1 unit

Part No.	Type	Pole number	Coding	Cable length m	Cable diameter mm	Operating voltage max. V	Rated current A	PU (units)
3 x 0.34 mm² (42 x 0.1)								
468020	S* KUW/LED A-M12 2M PUR	3	A	2.0	3.8	28	4	1
468050	S* KUW/LED A-M12 5M PUR	3	A	5.0	3.8	28	4	1
468100	S* KUW/LED A-M12 10M PUR	3	A	10.0	3.8	28	4	1
4 x 0.34 mm² (42 x 0.1)								
469020	S* KUW/LED P-M12 2M PUR	4	A	2.0	4.1	28	4	1
469050	S* KUW/LED P-M12 5M PUR	4	A	5.0	4.1	28	4	1
469100	S* KUW/LED P-M12 10M PUR	4	A	10.0	4.1	28	4	1

Pin layout

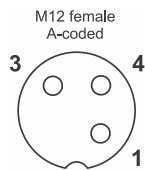

Circuit diagram

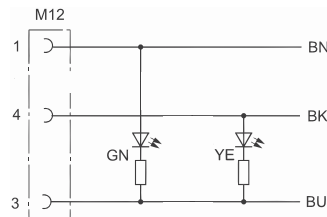

Pin layout

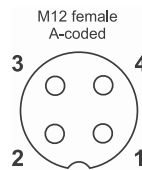

Circuit diagram

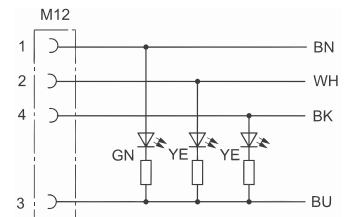

Actuator sensor interface - M12 / M12 - cables

Male M12 straight to female M12, straight with PUR cable
Self-locking screw connection
C-track compatible, halogen free



Properties

- Silicone free
- Free from paint wetting disruptive substances (LABS-free)
- Hydrolysis-resistant, microbe-resistant, and rot-resistant
- Resistance to acids, alkalines and watery solutions

Construction

Jacket material PUR
 Jacket color black
 Minimum bending radius moving 10×D

Technical data

Rated voltage U_N AC/DC 24 V
 Form male 1 M 12 male straight

Form male 2
 Degree of protection
 Color of the housing
 Mounting
 Temperature range connector
 Temperature range fixed
 Temperature range moving
 UV-resistant according to
 Certifications

Flamability according to UL 94
Accessories

M 12 female straight
 IP65/67/68
 black
 Breakaway torque 0.4 Nm
 -25 °C ... +90 °C
 -40 °C ... +80 °C
 -25 °C ... +80 °C
 DIN EN ISO 4892-2-A

cULus Listed (E224249)
 HB
Torque setting tool M 12: Part-No.
 490091 | DM-SET M12 | PU: 1 unit

Part No.	Type	Pole number	Coding	Cable length m	Cable diameter mm	Operating voltage max. V	Rated current A	PU (units)
4 × 0.34 mm² (42 × 0.1)								
429003	S* STG4-M12/ KUG4-M12 0,3M PUR	4	A	0.3	4.1	250	4	1
429006	S* STG4-M12/ KUG4-M12 0,6mPUR	4	A	0.6	4.1	250	4	1
429010	S* STG4-M12/ KUG4-M12 1,0M PUR	4	A	1.0	4.1	250	4	1
429015	S* STG4-M12/ KUG4-M12 1,5M PUR	4	A	1.5	4.1	250	4	1
429020	S* STG4-M12/ KUG4-M12 2,0M PUR	4	A	2.0	4.1	250	4	1
429050	S* STG4-M12/ KUG4-M12 5,0M PUR	4	A	5.0	4.1	250	4	1

PIN assignment

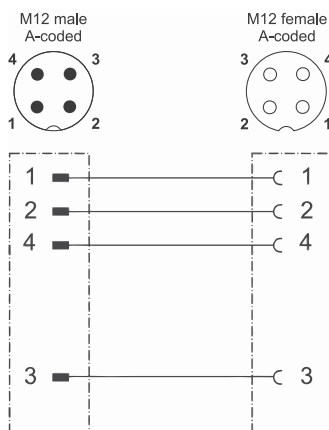

Actuator sensor interface - M12 / M12 - cables

Male M12 straight to female M12 straight with PUR cable
 Self-locking screw connection
 C-track compatible, halogen free



Properties

- Silicone free
- Free from paint wetting disruptive substances (LABS-free)
- Hydrolysis-resistant, microbe-resistant, and rot-resistant
- Resistance to acids, alkalines and watery solutions

Construction

Jacket material PUR
 Jacket color black
 Minimum bending radius moving 10×D

Technical data

Rated voltage U_N AC/DC 24 V
 Form male 1 M 12 male straight

Form male 2
 Degree of protection
 Color of the housing
 Mounting
 Temperature range connector
 Temperature range fixed
 Temperature range moving
 UV-resistant according to
 Certifications

Flamability according to UL 94
Accessories

M 12 female straight
 IP65/67/68
 black
 Breakaway torque 0.4 Nm
 -25 °C ... +90 °C
 -40 °C ... +80 °C
 -25 °C ... +80 °C
 DIN EN ISO 4892-2-A

cULus Listed (E224249)
 HB
Torque setting tool M 12: Part-No.
 490091 | DM-SET M12 | PU: 1 unit

Part No.	Type	Pole number	Coding	Cable length m	Cable diameter mm	Operating voltage max. V	Rated current A	PU (units)
5 × 0.34 mm² (42 × 0.1)								
442003	S* STG5-M12/ KUG5-M12 0,3M PUR	5	A	0.3	4.5	30	4	1
442006	S* STG5-M12/ KUG5-M12 0,6M PUR	5	A	0.6	4.5	30	4	1
442010	S* STG5-M12/ KUG5-M12 1,0M PUR	5	A	1.0	4.5	30	4	1
442015	S* STG5-M12/ KUG5-M12 1,5M PUR	5	A	1.5	4.5	30	4	1
442020	S* STG5-M12/ KUG5-M12 2,0M PUR	5	A	2.0	4.5	30	4	1
442050	S* STG5-M12/ KUG5-M12 5,0M PUR	5	A	5.0	4.5	30	4	1

PIN assignment

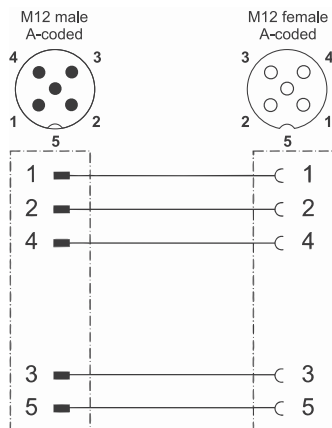

Actuator sensor interface - M12 / M12 - cables

Male M12 straight to female M12 straight with PUR cable
Self-locking screw connection
C-track compatible, halogen free



Properties

- Silicone free
- Free from paint wetting disruptive substances (LABS-free)
- Hydrolysis-resistant, microbe-resistant, and rot-resistant
- Resistance to acids, alkalines and watery solutions

Construction

Jacket material PUR
 Jacket color black
 Minimum bending radius moving 10xD

Technical data

Rated voltage U_N AC/DC 24 V
 Form male 1 M 12 male straight

Form male 2
 Degree of protection
 Color of the housing
 Mounting
 Temperature range connector
 Temperature range fixed
 Temperature range moving
 UV-resistant according to
 Certifications

Flamability according to UL 94
Accessories

M 12 female straight
 IP65/67/68
 black
 Breakaway torque 0.4 Nm
 -25 °C ... +90 °C
 -40 °C ... +80 °C
 -25 °C ... +80 °C
 DIN EN ISO 4892-2-A

cULus Listed (E224249)
 HB
Torque setting tool M 12: Part-No.
 490091 | DM-SET M12 | PU: 1 unit

Part No.	Type	Pole number	Coding	Cable length m	Cable diameter mm	Operating voltage max. V	Rated current A	PU (units)
8 x 0.25 mm² (32 x 0.1)								
420003	A* STG8-M12/ KUG8-M12 0,3M PUR	8	A	0.3	5.9	30	2	1
420006	A* STG8-M12/ KUG8-M12 0,6M PUR	8	A	0.6	5.9	30	2	1
420010	A* STG8-M12/ KUG8-M12 1,0M PUR	8	A	1.0	5.9	30	2	1
420015	A* STG8-M12/ KUG8-M12 1,5M PUR	8	A	1.5	5.9	30	2	1
420020	A* STG8-M12/ KUG8-M12 2,0M PUR	8	A	2.0	5.9	30	2	1
420050	S* STG8-M12/ KUG8-M12 5,0M PUR	8	A	5.0	5.9	30	2	1

PIN assignment

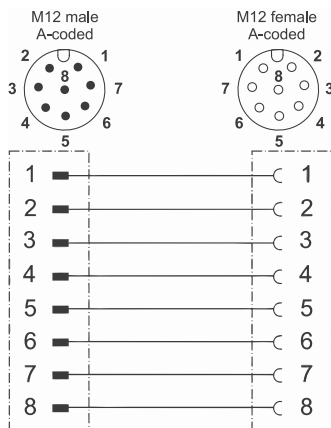

Actuator sensor interface - M12 / M12 - cables

Male M12 straight to female M12 angled with PUR cable
 Self-locking screw connection
 C-track compatible, halogen free



Properties

- Silicone free
- Free from paint wetting disruptive substances (LABS-free)
- Hydrolysis-resistant, microbe-resistant, and rot-resistant
- Resistance to acids, alkalines and watery solutions

Construction

Jacket material PUR
 Jacket color black
 Minimum bending radius moving 10xD

Technical data

Rated voltage U_N AC/DC 24 V
 Form male 1 M 12 male straight

Form male 2
 Degree of protection
 Color of the housing
 Mounting
 Temperature range connector
 Temperature range fixed
 Temperature range moving
 UV-resistant according to
 Certifications

Flamability according to UL 94
Accessories

M 12 female angle connector
 IP65/67/68
 black
 Breakaway torque 0.4 Nm
 -25 °C ... +90 °C
 -40 °C ... +80 °C
 -25 °C ... +80 °C
 DIN EN ISO 4892-2-A

cULus Listed (E224249)
 HB
Torque setting tool M 12: Part-No.
 490091 | DM-SET M12 | PU: 1 unit

Part No.	Type	Pole number	Coding	Cable length m	Cable diameter mm	Operating voltage max. V	Rated current A	PU (units)
4 x 0.34 mm² (42 x 0.1)								
418003	A* STG4-M12/ KUW4-M12 0,3M PUR	4	A	0.3	4.1	250	4	1
418006	A* STG4-M12/ KUW4-M12 0,6M PUR	4	A	0.6	4.1	250	4	1
418010	A* STG4-M12/ KUW4-M12 1,0M PUR	4	A	1.0	4.1	250	4	1
418015	A* STG4-M12/ KUW4-M12 1,5M PUR	4	A	1.5	4.1	250	4	1
418020	A* STG4-M12/ KUW4-M12 2,0M PUR	4	A	2.0	4.1	250	4	1
418050	A* STG4-M12/ KUW4-M12 5,0M PUR	4	A	5.0	4.1	250	4	1

PIN assignment

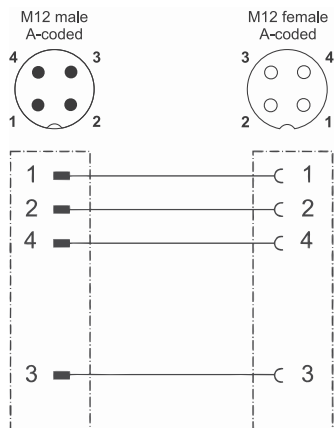

Actuator sensor interface - M12 / valve suppressor

Male M12 straight to valve connector form A
With protection device and LED status indication
C-track compatible, halogen free



Properties

- Silicone free
- Free from paint wetting disruptive substances (LABS-free)
- Hydrolysis-resistant, microbe-resistant, and rot-resistant
- Resistance to acids, alkalines and watery solutions

Construction

Jacket material PUR
 Jacket color black
 Minimum bending radius moving 10×D

Technical data

Rated voltage U_N AC/DC 24 V
 Protection device Z-diode + LED
 Cut-off peak ≤ 52 V
 Holding Capacity 100 VA
 Form male 1 M 12 male straight
 Form male 2 Valve connector form A
 Degree of protection IP65/67

Color of the housing black / transparent
 Mounting Breakaway torque 0.4 Nm
 Temperature range connector -20 °C ... +85 °C
 Temperature range fixed -40 °C ... +80 °C
 Temperature range moving -20 °C ... +80 °C
 UV-resistant according to Standards
 Certifications DIN EN ISO 4892-2-A
 EN 175301-803

Flamability according to UL 94
Accessories

Comments

cULus Listed (E224249)
 HB

Torque setting tool M 12: Part-No. 490091 | DM-SET M12 | PU: 1 unit
 Silicone free, Free from paint wetting impairment substances, resistant to microbes and hydrolysis Very good resistance to acids, alkalines and solvents.
 The material resistance is based on the application for use with aggressive media.

Part No.	Type	Pole number	Coding	Cable length m	Cable diameter mm	Operating voltage max. V	Rated current A	PU (units)
3 × 0.5 mm²								
435003	S* STG3-M12/LZ-A 0,3M PUR	3	A	0.3	4.5	28	4	1
435006	S* STG3-M12/LZ-A 0,6M PUR	3	A	0.6	4.5	28	4	1
435010	S* STG3-M12/LZ-A 1,0M PUR	3	A	1.0	4.5	28	4	1
435015	S* STG3-M12/LZ-A 1,5M PUR	3	A	1.5	4.5	28	4	1
435020	S* STG3-M12/LZ-A 2,0M PUR	3	A	2.0	4.5	28	4	1
435050	S* STG3-M12/LZ-A 5,0M PUR	3	A	5.0	4.5	28	4	1

Pin layout

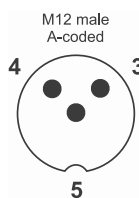

PIN assignment

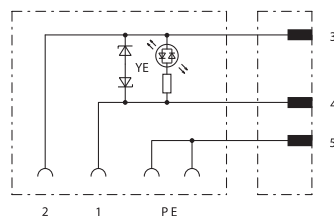

Actuator sensor interface - M12 / valve suppressor

Male M12 straight to valve suppressor form B / form BI
 With protection device and LED status indication
 C-track compatible, halogen free



Properties

- Silicone free
- Free from paint wetting disruptive substances (LABS-free)
- Hydrolysis-resistant, microbe-resistant, and rot-resistant
- Resistance to acids, alkalines and watery solutions

Construction

Jacket material PUR
 Jacket color black
 Minimum bending radius moving 10×D

Technical data

Rated voltage U_N AC/DC 24 V
 Protection device Z-diode + LED
 Cut-off peak ≤ 52 V
 Holding Capacity 100 VA
 Form male 1 M 12 male straight
 Form male 2 Valve connector form B Ind.
 Degree of protection IP65/67

Color of the housing black / transparent
 Mounting Breakaway torque 0.4 Nm
 Temperature range connector -25 °C ... +90 °C
 Temperature range fixed -40 °C ... +80 °C
 Temperature range moving -20 °C ... +80 °C
 UV-resistant according to DIN EN ISO 4892-2-A
 Certifications cULus Listed (E224249)
 HB

Flamability according to UL 94
Accessories

Comments

Torque setting tool M 12: Part-No. 490091 | DM-SET M12 | PU: 1 unit
 Silicone free, Free from paint wetting impairment substances, resistant to microbes and hydrolysis Very good resistance to acids, alkalines and solvents.
 The material resistance is based on the application for use with aggressive media.

Part No.	Type	Pole number	Coding	Cable length m	Cable diameter mm	Operating voltage max. V	Rated current A	PU (units)
3 × 0.5 mm²								
439003	A* STG3-M12/LZ-BI 0° 0,3M PUR	3	A	0.3	4.5	28	4	1
439010	A* STG3-M12/LZ-BI 0° 1,0M PUR	3	A	1.0	4.5	28	4	1
439006	A* STG3-M12/LZ-BI 0° 0,6M PUR	3	A	0.6	4.5	28	4	1
439015	A* STG3-M12/LZ-BI 0° 1,5M PUR	3	A	1.5	4.5	28	4	1
439020	A* STG3-M12/LZ-BI 0° 2,0M PUR	3	A	2.0	4.5	28	4	1
439050	A* STG3-M12/LZ-BI 0° 5,0M PUR	3	A	5.0	4.5	28	4	1

Pin layout

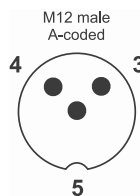

PIN assignment

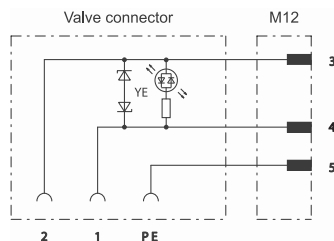

Actuator sensor interface - M8 - connector

Field wireable connector, M8 straight
Male / female
IDC quick-connect technology



Technical data

Rated voltage U_N
Connection type

AC/DC 24 V
IDC
0.25 mm² – 0.5 mm²
Breakaway torque 0.2 Nm
IP67
black

Mounting
Degree of protection
Color of the housing

Cable diameter
Temperature range connector
Mechanical service life
Certifications

2.5 mm – 5 mm
-40 °C ... +80 °C
>100 insertion cycles

Flamability according to UL 94

cURus (E256031)
HB

Part No.	Type	Pole number	Operating voltage max. V	Rated current A	PU (units)
M 8 male straight					
490123	S* STGK-M8 3 POL. SNK	3	60	4	1
490124	S* STGK-M8 4POL. SNK	4	60	4	1
M 8 female straight					
490125	S* KUGK-M8 3 POL. SNK	3	60	4	1
490126	S* KUGK-M8 4POL. SNK	4	60	4	1

Pin layout

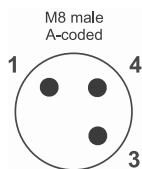

Pin layout

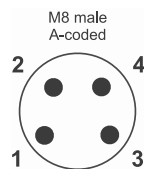

Pin layout

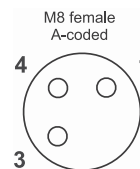

Pin layout

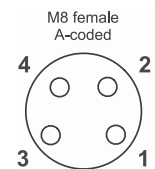

Actuator sensor interface - M8 - connector

Field wireable connector, M8 straight
Male / female
Screw terminal



Technical data

Rated voltage U_n
Connection type*

AC/DC 24 V
Screw terminal
0.14 mm² – 0.5 mm²
Breakaway torque 0.2 Nm
IP67
black

Mounting
Degree of protection
Color of the housing

Cable diameter
Temperature range connector
Mechanical service life
Certifications

3.5 mm – 5 mm
-25 °C ... +85 °C
>100 insertion cycles

Flamability according to UL 94

cULus Listed (E224249)
HB

Part No.	Type	Pole number	Operating voltage max. V	Rated current A	PU (units)
M 8 male straight					
490035	S* STGK-M8 3 POL. SK	3	60	4	1
490057	S* STGK-M8 4 POL. SK	4	60	4	1
M 8 female straight					
490037	S* KUGK-M8 3 POL. SK	3	60	4	1
490059	S* KUGK-M8 4 POL. SK	4	60	4	1

Pin layout

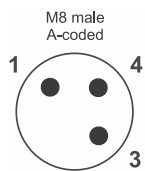

Pin layout

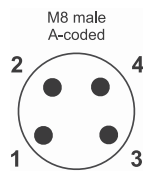

Pin layout

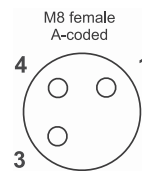

Pin layout

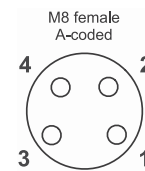

Actuator sensor interface - M12 - connector

Field wireable connector, M12 straight
 Male A-coded / Female A-coded
 Spring terminal: Push-in connection technology



Technical data

Rated voltage U_N
 Connection type

Degree of protection
 Color of the housing
 Cross-section, metric

Cross-section AWG

Cable diameter

AC/DC 24 V
 Spring terminal
 Push-In
 IP65, IP67 inserted and tightened
 black
 without ferrule: 0.14–0.75 mm²
 with ferrule: 0.08–0.5 mm²
 without ferrule: AWG26–AWG18
 with ferrule: AWG28–AWG20
 4 mm – 8 mm

Tightening torque

Temperature range connector
 Mechanical service life
 Certifications

Standards

Flamability according to UL 94

M12-knurled nut: 0.4 Nm
 sleeve housing: 0.4 Nm
 pressure nut: 1.5 Nm
 -40 °C ... +85 °C
 >100 insertion cycles

cULus Listed (E224249)
 IEC 61076-2-101
 EN 50155 (2001) vibration and shock
 V0

Part No.	Type	Pole number	Coding	Operating voltage max. V	Rated current A	PU (units)
M 12 male straight						
490190	S* STGK-M12 4-POL-A FK	4	A	250	4	1
490191	S* STGK-M12 5-POL-A FK	5	A	60	4	1
M 12 female straight						
490192	S* KUGK-M12 4-POL-A FK	4	A	250	4	1
490193	S* KUGK-M12 5-POL-A FK	5	A	60	4	1

Pin layout

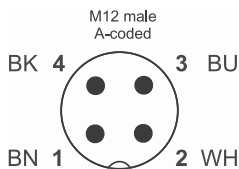

Pin layout

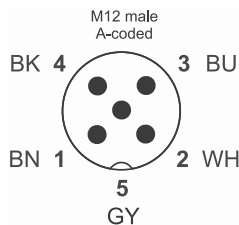

Pin layout

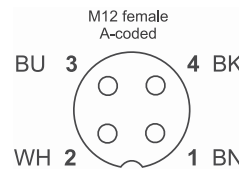

Pin layout

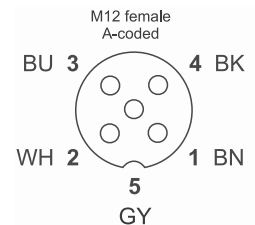

Actuator sensor interface - M12 - connector

Field wireable connector, M12 angled
 Male A-coded / Female A-coded
 Spring terminal: Push-in connection technology



Technical data

Rated voltage U_n
 Connection type⁶

Mounting

Degree of protection
 Color of the housing
 Cross-section, metric

Cross-section AWG

AC/DC 24 V
 Spring terminal
 Push-In
 Coding
 can be rotated in the 45° increments
 IP65, IP67 inserted and tightened
 black
 without ferrule: 0.14–0.75 mm²
 with ferrule: 0.08–0.5 mm²
 without ferrule: AWG26–AWG18
 with ferrule: AWG28–AWG20

Cable diameter
 Tightening torque

Temperature range connector
 Mechanical service life
 Certifications

Standards

Flamability according to UL 94

4 mm – 8 mm
 M12-knurled nut: 0.4 Nm
 sleeve housing: 0.4 Nm
 pressure nut: 1.5 Nm
 -40 °C ... +85 °C
 >100 insertion cycles

cULus Listed (E224249)
 IEC 61076-2-101
 EN 50155 (2001) vibration and shock
 V0

Part No.	Type	Pole number	Coding	Operating voltage max. V	Rated current A	PU (units)
M 12 male angle connector						
490194	S* STWK-M12 4-POL-A FK	4	A	250	4	1
490195	S* STWK-M12 5-POL-A FK	5	A	60	4	1
M 12 female angle connector						
490196	S* KUWK-M12 4-POL-A FK	4	A	250	4	1
490197	S* KUWK-M12 5-POL-A FK	5	A	60	4	1

Pin layout

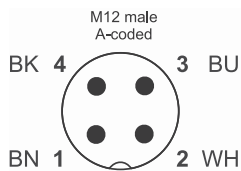

Pin layout

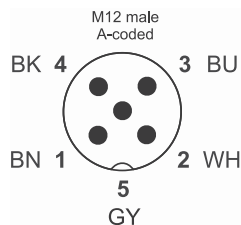

Pin layout

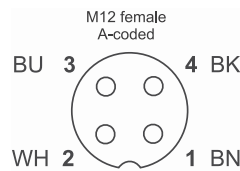

Pin layout

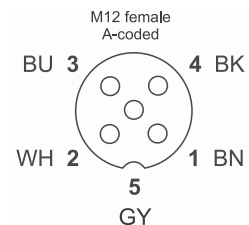

Actuator sensor interface - M12 - connector

Field wireable connector, M12 straight
 Male A-coded / Female A-coded
 Fast connection method, IDC termination



Technical data

Rated voltage U_N
 Connection type

Mounting
 Degree of protection
 Color of the housing

AC/DC 24 V
 Compliant terminal
 IDC
 Breakaway torque 0.4 Nm
 IP67
 black

Cross-section, metric
 Cable diameter
 Temperature range connector
 Mechanical service life
 Certifications

Flamability according to UL 94

0.75 mm²
 4 mm – 7.5 mm
 -25 °C ... +80 °C
 >100 insertion cycles
 cULus Listed (E224249)
 V0

Part No.	Type	Pole number	Coding	Operating voltage max. V	Rated current A	PU (units)
M 12 male straight						
490028	S* STGK-M12 4POL.SNK	4	A	250	4	1
M 12 female straight						
490029	S* KUGK-M12 4POL. SNK	4	A	250	4	1

Pin layout

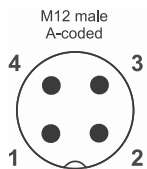

Pin layout

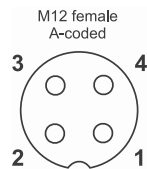

Actuator sensor interface - M12 - connector

Field wireable connector, M12 straight
Male - A coded
Screw terminal



Technical data

Rated voltage U_n

Connection type*

Mounting
Degree of protection

AC/DC 24 V
Screw terminal
max. 0.75 mm²
Breakaway torque 0.4 Nm
IP67

Color of the housing
Temperature range connector
Mechanical service life
Certifications

Flamability according to UL 94

black
-25 °C ... +85 °C
>100 insertion cycles

cURus (E224249)
HB

Part No.	Type	Pole number	Coding	Operating voltage max. V	Rated current A	Cable diameter	Cross-section, metric mm ²	PU (units)
M 12 male straight								
490017	S* STGK-M12 4POL.SK PG7	4	A	250	4	4 mm – 6 mm	0.75	1
490018	S* STGK M12 5 POL. SK PG7	5	A	250	4	4 mm – 6 mm	0.75	1
490070	S* STGK M12 8 POL. SK PG9	8	A	60	2	6 mm – 8 mm	0.5	1

Pin layout

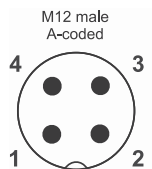

Pin layout

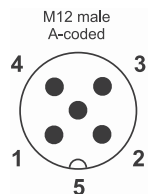

Pin layout

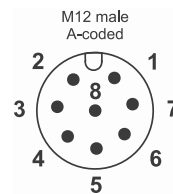

Actuator sensor interface - M12 - connector

Field wireable connector, M12 straight
 Female - A coded
 Screw terminal



Technical data
 Rated voltage U_N
 Connection type

AC/DC 24 V
 Screw terminal
 max. 0.75 mm²
 Breakaway torque 0.4 Nm
 IP67

Color of the housing
 Temperature range connector
 Mechanical service life
 Certifications

black
 -25 °C ... +85 °C
 >100 insertion cycles

Mounting
 Degree of protection

Flamability according to UL 94

cURus (E224249)
 HB

Part No.	Type	Pole number	Coding	Operating voltage max. V	Rated current A	Cable diameter	Cross-section, metric mm ²	PU (units)
M 12 female straight								
490011	S* KUGK-M12 4POL. SK PG7	4	A	250	4	4 mm – 6 mm	0.75	1
490012	S* KUGK-M12 5pol. SK PG7	5	A	60	4	4 mm – 6 mm	0.75	1
490071	S* KUGK-M12 8POL. SK PG9	8	A	30	2	6 mm – 8 mm	0.5	1

Pin layout

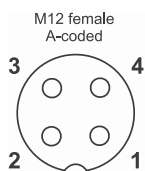

Pin layout

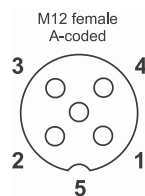

Pin layout

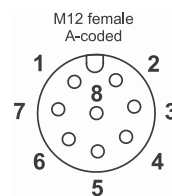

Actuator sensor interface - M12, M12/M8 -connector

Splitter

Male M12 to 2x female M12, 5pin PIN 2+4 bridged + PE

Male M12 4pin to 2x female M8, 3pin



Technical data

Rated voltage U_N
Mounting

Color of the housing

AC/DC 24 V
M 12: 0,4 Nm
M 8: 0,2 Nm
black

Temperature range connector
Mechanical service life
Certifications

Flamability according to UL 94

-25 °C ... +90 °C
>100 insertion cycles

cULus Listed (E224249)
HB

Part No.	Type	Pole number	Coding	Operating voltage max. V	Rated current A	PU (units)
M 12/M 12						
490026	S* AST M 12/2xM 12	5	A	60	4	1
M 12/M 8						
490038	S* T-VERTEILER M12 AUF 2x M8	3	A	30	3	1

PIN assignment

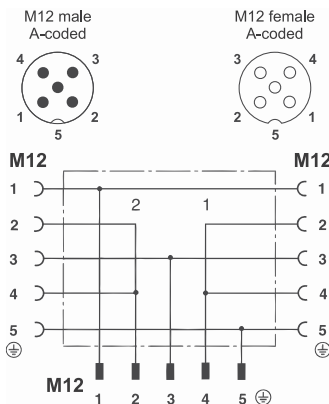

PIN assignment

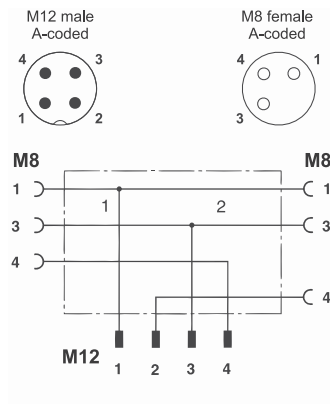

Actuator sensor interface - M12 - connector

Field wireable connector, M12 straight, shielded
 Female / Male A-coded (CAN), B-coded (Profibus, Interbus)
 Spring terminal: Push-in connection technology



Technical data

Rated voltage U_N
 Connection type

Degree of protection
 Color of the housing
 Cross-section, metric

Cross-section AWG

Cable diameter

AC/DC 24 V
 Spring terminal
 Push-In
 IP65, IP67 inserted and tightened
 silver
 without ferrule: 0.14–0.75 mm²
 with ferrule: 0.08–0.5 mm²
 without ferrule: AWG26–AWG18
 with ferrule: AWG28–AWG20
 4 mm – 8 mm

Tightening torque

Temperature range connector
 Mechanical service life
 Certifications

Standards

Flamability according to UL 94

M12-knurled nut: 0.4 Nm
 sleeve housing: 0.8 Nm
 pressure nut: 3 Nm
 -40 °C ... +85 °C
 >100 insertion cycles

cULus Listed (E224249)
 IEC 61076-2-101
 EN 50155 (2001) vibration and shock
 V0

Part No.	Type	Pole number	Coding	Operating voltage max. V	Rated current A	PU (units)
M 12 male straight						
490200	S* STGK5-M12 (C)-A FK	5	A	60	4	1
490210	S* STGK2-M12 (C)-B FK	2	B	60	4	1
M 12 female straight						
490201	S* KUGK5-M12 (C)-A FK	5	A	60	4	1
490211	S* KUGK2-M12 (C)-B FK	2	B	60	4	1

Pin layout

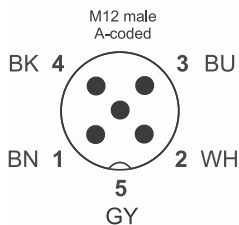

Pin layout

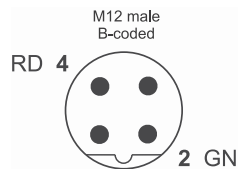

Pin layout

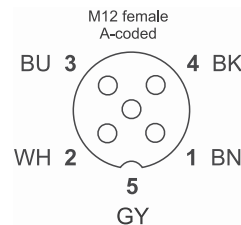

Pin layout

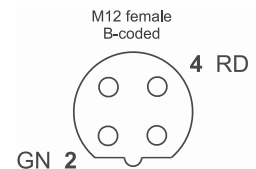

Actuator sensor interface - M12 - connector

Field wireable connector, M12 straight, shielded
 Female / Male D-coded (Ethernet, Profinet)
 Spring terminal: Push-in connection technology



Technical data

Rated voltage U_n
 Connection type*

Degree of protection
 Color of the housing
 Cross-section, metric

Cross-section AWG

Cable diameter

AC/DC 24 V
 Spring terminal
 Push-In
 IP65, IP67 inserted and tightened
 silver
 without ferrule: 0.14–0.75 mm²
 with ferrule: 0.08–0.5 mm²
 without ferrule: AWG26–AWG18
 with ferrule: AWG28–AWG20
 4 mm – 8 mm

Tightening torque

Temperature range connector
 Mechanical service life
 Certifications

Standards

Flamability according to UL 94

M12-knurled nut: 0.4 Nm
 sleeve housing: 0.8 Nm
 pressure nut: 3 Nm
 -40 °C ... +85 °C
 >100 insertion cycles

cULus Listed (E224249)
 IEC 61076-2-101
 EN 50155 (2001) vibration and shock
 V0

Part No.	Type	Pole number	Coding	Operating voltage max. V	Rated current A	PU (units)
M 12 male straight						
490212	S* STGK4-M12 (C)-D FK	4	D	60	4	1
M 12 female straight						
490213	S* KUGK4-M12 (C)-D FK	4	D	60	4	1

Pin layout

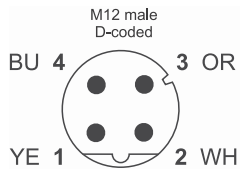

Pin layout

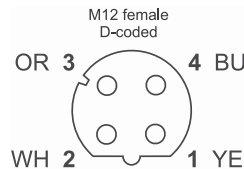

Actuator sensor interface - M12 - connector

Field wireable connector, M12 angled, shielded
 Female / Male A-coded (CAN), D-coded (Ethernet, Profinet)
 Spring terminal: Push-in connection technology



Technical data
 Rated voltage U_N
 Connection type

Mounting

Degree of protection
 Color of the housing
 Cross-section, metric

Cross-section AWG

AC/DC 24 V
 Spring terminal
 Push-In
 Coding
 can be rotated in the 45° increments
 IP65, IP67 inserted and tightened
 silver
 without ferrule: 0.14–0.75 mm²
 with ferrule: 0.08–0.5 mm²
 without ferrule: AWG26–AWG18
 with ferrule: AWG28–AWG20

Cable diameter
 Tightening torque

Temperature range connector
 Mechanical service life
 Certifications

Standards

Flamability according to UL 94

4 mm – 8 mm
 M12-knurled nut: 0.4 Nm
 sleeve housing: 0.8 Nm
 pressure nut: 3 Nm
 -40 °C ... +85 °C
 >100 insertion cycles

cULus (E224249)
 IEC 61076-2-101
 EN 50155 (2001) vibration and shock
 V0

Part No.	Type	Pole number	Coding	Operating voltage max. V	Rated current A	PU (units)
M 12 male angle connector						
490202	S* STWK5-M12 (C)-A FK	5	A	60	4	1
490214	S* STWK4-M12 (C)-D FK	4	D	60	4	1
M 12 female angle connector						
490203	S* KUWK5-M12 (C)-A FK	5	A	60	4	1
490215	S* KUWK4-M12 (C)-D FK	4	D	60	4	1

Pin layout

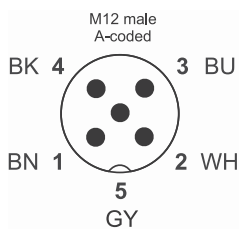

Pin layout

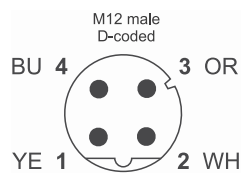

Pin layout

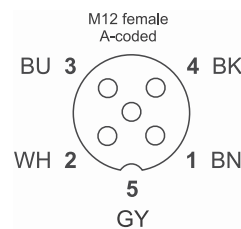

Pin layout

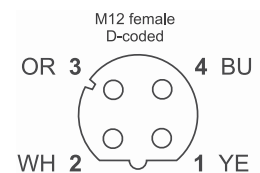

Actuator sensor interface - M12 - connector

Field wireable connector, M12 straight shielded
Male / female - A coded
Screw terminal



Technical data

Rated voltage U_n
Connection type*

AC/DC 24 V
Screw terminal
max. 0.75 mm²
Breakaway torque 0.4 Nm
IP67

Temperature range connector
Mechanical service life
Certifications

-25 °C ... +85 °C
>100 insertion cycles

Mounting
Degree of protection

Flamability according to UL 94

cJURus (E224249)
HB

Part No.	Type	Pole number	Coding	Operating voltage max. V	Rated current A	Cable diameter	Cross-section, metric mm ²	PU (units)
M 12 male straight								
490054	S* STGK8-M12(C) 8-POL. A-cod. SK	8	A	30	2	6 mm – 8 mm	0.5	1
M 12 female straight								
490077	S* KUGK8-M12(C) 8-POL. A-cod. SK	8	A	30	2	6 mm – 8 mm	0.5	1

Pin layout

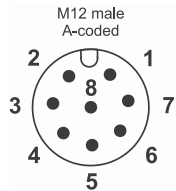

Pin layout

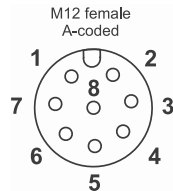

Actuator sensor interface - M12 - connector

Field wireable connector, M12 straight shielded
 Male - X coded Cat.6_A (Ethernet, Profinet)
 Fast connection method, IDC termination



Technical data

Rated voltage U_N
 Connection type

Degree of protection
 Cross-section AWG

AC/DC 24 V
 Compliant terminal
 IDC
 IP65/67
 26-22

Cable diameter
 Temperature range connector
 Mechanical service life
 Flamability according to UL 94
 Comments

5 mm – 9.7 mm
 -40 °C ... +85 °C
 >100 insertion cycles
 V0
 Suitable cables, see overview assignment Ethernet cables to connectors

Part No.	Type	Pole number	Coding	Operating voltage max. V	Rated current A	PU (units)
M 12						
490167	S* STGK8-M12(C) 8pol. X-kod. Cat.6A	8	X	60	0.5	1
490168	S* KUGK8-M12(C) 8pol. X-kod. Cat.6A	8	X	60	0.5	1

Pin layout

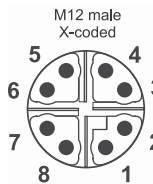

Pin layout

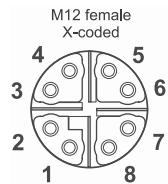

Actuator sensor interface - RJ45 connector

Industrial connector RJ45

Solid metal housing, quick-connect technology AWG 27–22

Cat.6_A, protective cover pre-assembled



Technical data

Rated voltage U_n
Connection type*

30 V
8-pin RJ45
Push-through contacts
IPC

Mechanical service life
Dimensions (w × h × d)
Certifications

>750 insertion cycles
13.9 mm × 16.3 mm × 53.8 mm

Rated current
Design
Degree of protection
Color of the housing
Cable diameter
Operation temperature range

≤1 A per contact
RJ45
IP20
silver
5.5 mm – 10 mm
-40 °C ... +85 °C

Flamability according to UL 94
Comments

cULus Listed (E326112)
V0
Suitable for Profinet, SERCOS3, Ethercat, Ethernet/IP, Powerlink, VARAN, Power over Ethernet+ (PoE+IEEE 802.3at)
Suitable cables, see overview assignment Ethernet cables to connectors

Part No.	Type	Pole number	Bandwidth	Transfer rate	Category	Strand diameter	Cross-section AWG	PU (units)
8-pin RJ45 Push-through contacts IPC								
490174	S* RJ45-M 8pol. Cat.6A T568B	8	500 MHz	10 Gbit/s	Cat.6 _A	1 mm – 1.6 mm	24-22/1, 24-22/7, 19	1
490175	S* RJ45-M 8pol. Cat.6A T568A	8	500 MHz	10 Gbit/s	Cat.6 _A	1 mm – 1.6 mm	24-22/1, 24-22/7, 19	1
490176	S* RJ45-M 8pol. Cat.6A T568B AWG 26	8	500 MHz	10 Gbit/s	Cat.6 _A	0.85 mm – 1.1 mm	26-24/1, 27-24/7, 26/19	1
4-pin RJ45 Push-through contacts IPC								
490177	S* RJ45-MS 4pol. PROFINET	4	100 MHz	1 Gbit/s	Cat.5e	1 mm – 1.6 mm	24-22/1, 24-22/7, 19	1

Connection assignment

RJ45 male
Ethernet T568B

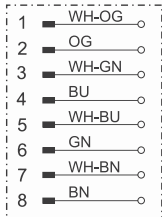

Connection assignment

RJ45 male
Ethernet T568A

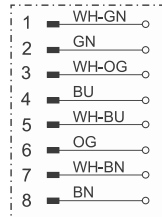

Connection assignment

RJ45 male
PROFINET

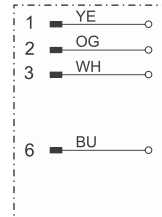

Actuator sensor interface - RJ45 connector

Industrial connector RJ45

Solid metal housing, quick-connect technology AWG 27–22

Cat.6_A, 4 levels cable clamp, protective cover pre-assembled



CC-Link IE Field

Technical data

Rated voltage U_N
Connection type

Rated current
Contact type
Design
Degree of protection
Color of the housing

Cable diameter
Operation temperature range

30 V
8-pin RJ45
Push-through contacts
IPC
 ≤ 1 A
Penetration contact
RJ45
IP20
silver
5 mm – 9 mm
-40 °C ... +70 °C

Mechanical service life
Dimensions (w × h × d)
Certifications

Flamability according to UL 94
Comments

>750 insertion cycles
13.8 mm × 16.2 mm × 53.1 mm

cULus Listed (E326112)
V0
Suitable for Profinet, SERCOS3, Ethercat, Ethernet/IP, Powerlink, VARAN, Power over Ethernet+ (PoE+IEEE 802.3at)
Suitable cables, see overview assignment Ethernet cables to connectors

Part No.	Type	Pole number	Bandwidth	Transfer rate	Category	Strand diameter	Cross-section AWG	PU (units)
8-pin RJ45 Push-through contacts IPC								
490128	S* RJ45-M 8pol. Cat.6A T568B	8	500 MHz	10 Gbit/s	Cat.6 _A	1 mm – 1.6 mm	24/1-22/1, 27/7-22/7	1
490129	S* RJ45-M 8pol. Cat.6A T568A	8	500 MHz	10 Gbit/s	Cat.6 _A	1 mm – 1.6 mm	24/1-22/1, 27/7-22/7	1
490138	S* RJ45-M 8pol. Cat.6A T568B AWG 26/19	8	500 MHz	10 Gbit/s	Cat.6 _A	0.85 mm – 1.1 mm	26/1, 26/7, 26/19	1

Connection assignment

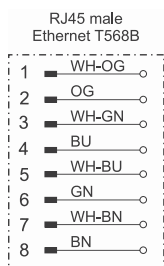

Connection assignment

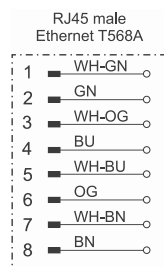

Actuator sensor interface - RJ45 connector

Industrial connector RJ45, angled

Solid metal housing, quick-connect technology AWG 27–22

Cat.6_A / Cat 5e



Technical data

Rated voltage U_n
Connection type*

30 V
8-pin RJ45
Push-through contacts
IPC

Rated current
Design

≤1 A per contact
RJ45

Degree of protection
Color of the housing

angle connector
IP20
silver

Cable diameter
Operation temperature range

5.5 mm – 10 mm
-40 °C ... +85 °C

Mechanical service life
Dimensions (w × h × d)
Certifications

>750 insertion cycles
13.9 mm × 38.0 mm × 45.7 mm

Flamability according to UL 94
Comments

cULus Listed (E326112)
V0
Suitable for Profinet, SERCOS3, Ethercat, Ethernet/IP, Powerlink, VARAN, Power over Ethernet+ (PoE+IEEE 802.3at)
Suitable cables, see overview assignment Ethernet cables to connectors

Part No.	Type	Pole number	Bandwidth	Transfer rate	Category	Strand diameter	Cross-section AWG	PU (units)
8-pin RJ45 Push-through contacts IPC								
490151	S* RJ45-MR 8pol. Cat.6A T568B	8	500 MHz	10 Gbit/s	Cat.6 _A	1 mm – 1.6 mm	24-22/1, 24-22/7, 19	1
490152	S* RJ45-MR 8pol. Cat.6A T568A	8	500 MHz	10 Gbit/s	Cat.6 _A	1 mm – 1.6 mm	24-22/1, 24-22/7, 19	1
490153	S* RJ45-MR 8pol. Cat.6A T568B AWG 26/19	8	500 MHz	10 Gbit/s	Cat.6 _A	0.85 mm – 1.1 mm	26-24/1, 27-24/7, 19	1
4-pin RJ45 Push-through contacts IPC								
490178	S* RJ45-MR 4pol. PROFINET	4	100 MHz	1 Gbit/s	Cat.5e	1 mm – 1.6 mm	24-22/1, 24-22/7, 19	1

Connection assignment

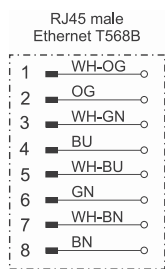

Connection assignment

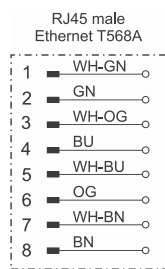

Connection assignment

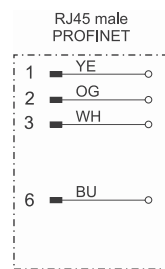

Actuator sensor interface

Module holder, RJ45, female / IDC For TS35 DIN rail Cat.6_A



Technical data

Rated voltage U_N
Connection type
Rated current
Contact type
Design
Degree of protection
Color of the housing

AC/DC 24 V
Compliant terminal
 ≤ 1 A per contact
IDC
RJ45
female
IP20 (EN 60529)
grey

Operation temperature range
Mechanical service life
Dimensions (w x h x d)
Certifications
Flamability according to UL 94
Comments

-40 °C ... +70 °C
>750 insertion cycles
18.0 mm x 70.5 mm x 65.7 mm
cULus Listed (E326112)
V0
Suitable cables, see overview assignment Ethernet cables to connectors

Part No.	Type	Pole number	Bandwidth	Transfer rate	Category	Strand diameter	Cross-section AWG	PU (units)
Compliant terminal								
490209	S* MDT-RJ45 F 8pol. Cat.6A TIA 568B	8	500 MHz	10 Gbit/s	Cat.6 _A	0.9 mm – 1.6 mm	27-22/7, 26-22/1	1
Compliant terminal AWG 27-22/7 AWG 26-22/1								
490238	S* MDT-RJ45 F 8pol. Cat.6A TIA 568A	8	500 MHz	10 Gbit/s	Cat.6 _A	0.9 mm – 1.6 mm	27-22/7	1

PIN assignment

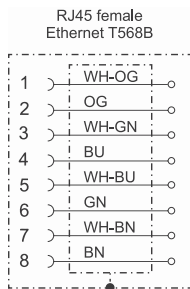

PIN assignment

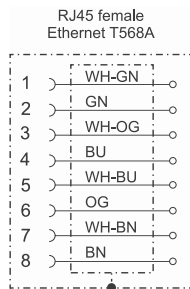

Actuator sensor interface - M8 panel jack

M8 panel connectors using M8 thread

Male / female

0.5 m TPE wire



Technical data

Mounting	Front installation
Cable length	Fastening thread M8 × 0,5
Degree of pollution	0.5 m
Insulation resistance	3
Contact resistance	>100 MΩ
Degree of protection	<3 mΩ
Housing material	IP67
Contact material	Zinc die-casting
Thread material	CuZn, gold-plated
Conductor insulation	CuZn nickel-plate
Storage temperature range	TPE
	-40 °C ... +85 °C

Temperature range connector	-25 °C ... +85 °C
Connection type	M 8
Mechanical service life	>100 insertion cycles
PU (units)	1
Flamability according to UL 94	HB
Accessories	Included in the delivery: M8 lock nut

Comments

Connection assignment Pole / wire color:
1/ BN (Brown) – 2/ WH (White) – 3/ BU (Blue) – 4/ BK (Black)
1/ BN (Brown) – 2/ WH (White) – 3/ BU (Blue) – 4/ BK (Black)

Part No.	Type	Pole number	Coding	Operating voltage max. V	Rated current A	Cross-section, metric mm ²	PU (units)
M 8x1 male							
490062	A* STGE-M8 3pol. 0,5m Litze	3	A	60	4	0.25	1
490063	A* STGE-M8 4pol. 0,5m Litze	4	A	30	4	0.25	1
M 8x1 female							
490060	S* KUGE-M8 3pol. 0,5m Litze	3	A	60	4	0.25	1
490061	S* KUGE-M8 4pol. 0,5m Litze	4	A	30	4	0.25	1

Pin layout

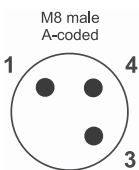

Pin layout

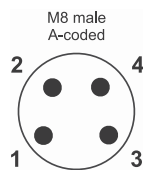

Actuator sensor interface - M12 panel jack

M12 connectors panel mounted using M16 thread
 Male A-coded / Female A-coded
 0.5 m TPE wire



Technical data

Mounting Front installation
 Fastening thread M16 × 1,5
 Cable length 0.5 m
 Degree of pollution 3
 Insulation resistance >100 MΩ
 Contact resistance <3 mΩ
 Degree of protection IP67
 Housing material Zinc die-casting
 Contact material CuZn, gold-plated
 Thread material CuZn nickel-plate
 Conductor insulation TPE

Storage temperature range -40 °C ... +85 °C
 Temperature range connector -25 °C ... +85 °C
 Connection type M 16
 Mechanical service life >100 insertion cycles
 PU (units) 1
 V0
Counter nut M16: Part-No. 600361 | GMS M16 | PU: 100 units
Connection assignment Pole / wire color:
 1/ BN (Brown) – 2/ WH (White) – 3/ BU (Blue) – 4/ BK (Black)

Comments

Part No.	Type	Pole number	Coding	Operating voltage max. V	Rated current A	Cross-section, metric mm ²	PU (units)
M 12x1							
490067	S* STGE-M12 4pol. 0,5m Litze	4	A	250	4	0.34	1
490068	S* STGE-M12 5pol. 0,5m Litze	5	A	60	4	0.34	1
490069	S* STGE-M12 8pol. 0,5m Litze	8	A	30	2	0.25	1
490064	S* KUGE-M12 4pol. 0,5m Litze	4	A	250	4	0.34	1
490065	S* KUGE-M12 5pol. 0,5m Litze	5	A	60	4	0.34	1
490066	S* KUGE-M12 8pol. 0,5m Litze	8	A	30	2	0.25	1

Pin layout

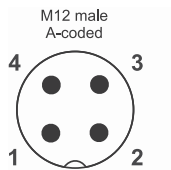

Pin layout

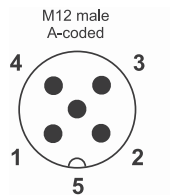

Pin layout

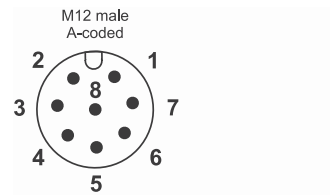

Actuator sensor interface - USB Panel pass through devices

USB 3.0 panel connector with M22 thread for front installation USB connector Type A on straight USB plug Type A with PVC cable



Construction

Jacket material
Jacket color

PVC
black

Technical data

Rated voltage U_N
Transfer rate
USB standard
Contact type
Form male 1
Form male 2
Degree of protection

AC/DC 5 V
5 Gbit/s
3.0
1 : 1
USB 3.0 female Type A
USB 3.0 male Type A
IP65 UL50E Typ 2, 3R, 4, 4X, 12, 13 in

Cover
Mounting
Temperature range fixed
Temperature range moving
Operation temperature range
Mechanical service life
Certifications

Accessories

closed and IP20 in inserted position
TPU
Front installation
-25 °C ... +80 °C
-5 °C ... +70 °C
-5 °C ... +70 °C
1500 insertion cycles

cULus Listed (E326112)
Included in the delivery:
attached safety cap

Part No.	Type	Pole number	Cable length m	Cable diameter mm	Operating voltage max. V	Rated current A	PU (units)
USB-A							
490113.0030	S* USB-3.0 A/A F/M 0,3m PVC	9	0.3	6.1	30	0.9	1
490113.0060	S* USB-3.0 A/A F/M 0,6m PVC	9	0.6	6.1	30	0.9	1
490113.0080	S* USB-3.0 A/A F/M 0,8m PVC	9	0.8	6.1	30	0.9	1
490113.0150	S* USB-3.0 A/A F/M 1,5m PVC	9	1.5	6.1	30	0.9	1
490113.0200	S* USB-3.0 A/A F/M 2,0m PVC	9	2.0	6.1	30	0.9	1
490113.0300	S* USB-3.0 A/A F/M 3,0m PVC	9	3.0	6.1	30	0.9	1
490113.0500	S* USB-3.0 A/A F/M 5,0m PVC	9	5.0	6.1	30	0.9	1
490113.0100	S* USB-3.0 A/A F/M 1,0m PVC	9	1.0	6.1	30	0.9	1

Mounting diagram

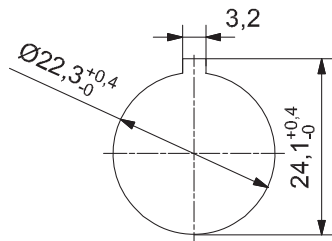

PIN assignment

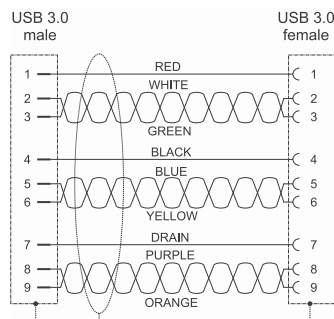

Pin layout

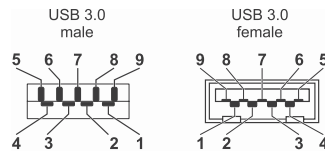

Actuator sensor interface - USB Panel pass through devices

USB 3.0 panel connector with M22 thread for front installation

USB 3.0 female / female Type A/A

Type: USB-3.0 A/A F/F



Technical data

Rated voltage U_N
Transfer rate
USB standard
Contact type
Degree of protection

AC/DC 5 V
5 Gbit/s
3.0
1 : 1
IP65 UL50E Typ 2, 3R, 4, 4X, 12, 13 in closed and IP20 in inserted position
TPU

Mounting
Operation temperature range
Mechanical service life
Certifications

Front installation
-20 °C ... +70 °C
>100 insertion cycles

cULus Listed (E326112)
Included in the delivery:
attached safety cap

Cover

Accessories

Part No.	Type	Pole number	Operating voltage max. V	Rated current A	PU (units)
USB 3.0 female/female type A/A					
490112	S* USB-3.0 A/A F/F	9	30	0.9	1

Mounting diagram

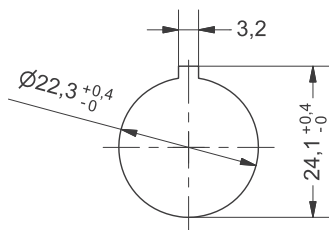

PIN assignment

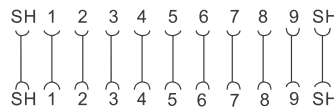

Pin layout

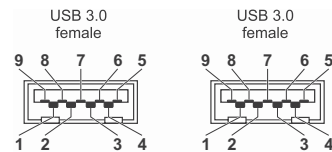

Actuator sensor interface - RJ45 Panel pass through devices

RJ45 panel connector with M22 thread for front installation

Female/female 1:1

Cat.6_A / Cat 5e



Technical data

Rated voltage U_n	AC 24 V
Operating voltage max.	50 V
Rated current	1.5 A
Contact type	1 : 1
Shielding	connected through
Form male 1	RJ45
Degree of pollution	3
Insulation resistance	>100 MΩ
Contact resistance	<30 mΩ
Degree of protection	IP65 UL50E Typ 2, 3R, 4, 4X, 12, 13 in closed and IP20 in inserted position
Housing material	PA, PBT

Cover	TPU
Contact material	CuSn, gold-plated
Mounting	Front installation
Installation depth	approx.70 mm
Temperature range connector	-25 °C ... +70 °C
Operation temperature range	-25 °C ... +70 °C
Storage temperature range	-25 °C ... +80 °C
PU (units)	1
Mechanical service life	>750 insertion cycles
Certifications	cULus Listed (E326112)

Accessories

Included in the delivery:
attached safety cap

Part No.	Type	Pole number	Bandwidth	Transfer rate	Category	PU (units)
RJ45						
492075	S* RJ45 F/F 8/8 Cat.5e	8	100 MHz	1 Gbit/s	Cat.5e	1
492076	S* RJ45 F/F 8/8 Cat.6A	8	500 MHz	10 Gbit/s	Cat.6 _A	1

Mounting diagram

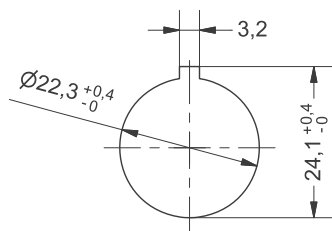

Circuit diagram

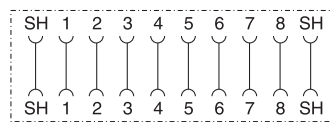

Pin layout

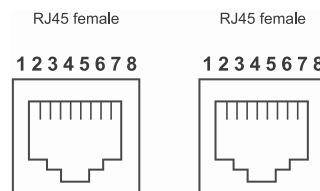

Actuator sensor interface - RJ45 Panel pass through devices

Control cabinet bushing M12 - RJ45

Female/female 1:1

Cat 5e (Ethernet, Profinet)



Technical data

Rated voltage U_n	24 V	Contact material	Phosphor Bronze, gold-plated
Operating voltage max.	50 V	Mounting	Rear wall assembly
Contact type	1 : 1	Installation depth	Fastening thread M16 × 1,5
Shielding	360°	Temperature range connector	approx. 70 mm
Form male 1	RJ45 M 12 female	Operation temperature range	-25 °C ... +85 °C
Insulation resistance	>100 MΩ	Storage temperature range	-25 °C ... +85 °C
Contact resistance	<30 mΩ	PU (units)	1
Degree of protection	IP67	Mechanical service life	>750 insertion cycles
Housing material	PA	Flamability according to UL 94	V0

Part No.	Type	Pole number	Coding	Bandwidth	Transfer rate	Category	PU (units)
RJ45/M 12x1							
490105	S* M12-RJ45 F/F 90° 4/4 Cat.5e Profinet	4	D	100 MHz	1 Gbit/s	Cat.5e	1
490106	S* M12-RJ45 F/F 180° 4/4 Cat.5e Profinet	4	D	100 MHz	1 Gbit/s	Cat.5e	1

Mounting diagram

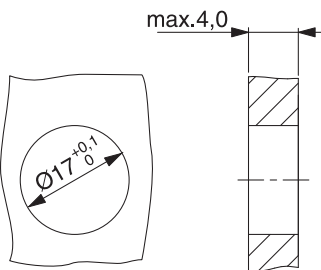

Circuit diagram

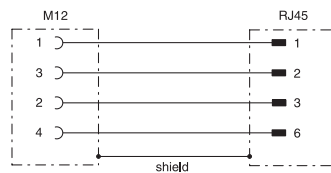

Pin layout

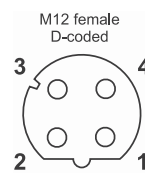

Pin layout

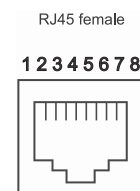

Actuator sensor interface - RJ45 Panel pass through devices

Control cabinet bushing M12 CAT6A X encoded - RJ45

Female/female 1:1

Cat.6_A (Ethernet, Profinet)



Technical data

Operating voltage max.
Shielding
Form male 1
Insulation resistance
Contact resistance
Degree of protection

60 V
360°
RJ45 M 12 female
>100 MΩ
<5 mΩ
IP67
IP68
CuSnZn

Contact material

Mounting

Installation depth
Temperature range connector
Operation temperature range
Storage temperature range
PU (units)
Mechanical service life

Rear wall assembly
Fastening thread M16 × 1,5
approx. 47 mm
-40 °C ... +85 °C
-40 °C ... +85 °C
-40 °C ... +85 °C
1
>500 insertion cycles

Part No.	Type	Pole number	Coding	Bandwidth	Transfer rate	Category	PU (units)
RJ45/M 12x1							
490230	M12-RJ45 F/F 90° 8/8 Cat.6A	8	X	500 MHz	10 Gbit/s	Cat.6 _A	1
490231	M12-RJ45 F/F 180° 8/8 Cat.6A	8	X	500 MHz	10 Gbit/s	Cat.6 _A	1

Circuit diagram

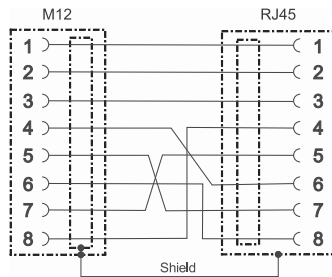

Pin layout

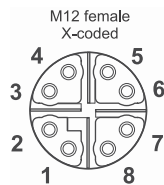

Pin layout

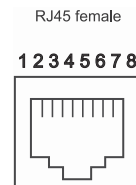

Actuator sensor interface

Protective coverage

M12

Color: black



Technical data

Connection type M 12 × 1
Housing material PA
Color black
Temperature range connector -20 °C ... +80 °C

Operation temperature range
Storage temperature range
PU (units)
Flamability according to UL 94

-20 °C ... +80 °C
-20 °C ... +80 °C
100
V0

Part No.	Type	PU (units)
499994	S* SK M12 FUER BUCHSE	100

Dimensions

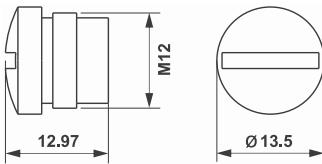

Customizable M12 connectors for data and signals

The customizable M12 connectors provide you with the best possible connection technology for every single application. The push-in connectors simplify the field installation of flexible conductors.

Your advantages:

- always the best connection technology for your M12 application
- Simple and tool-free connection with push-in technology
- Up to 30% time saving compared to the conventional screw terminal connection
- Better contact in case of vibration and shock load due to permanent spring pressure
- No conductor sleeves required

Main features:

- Shielded and unshielded versions
- male straight and angled

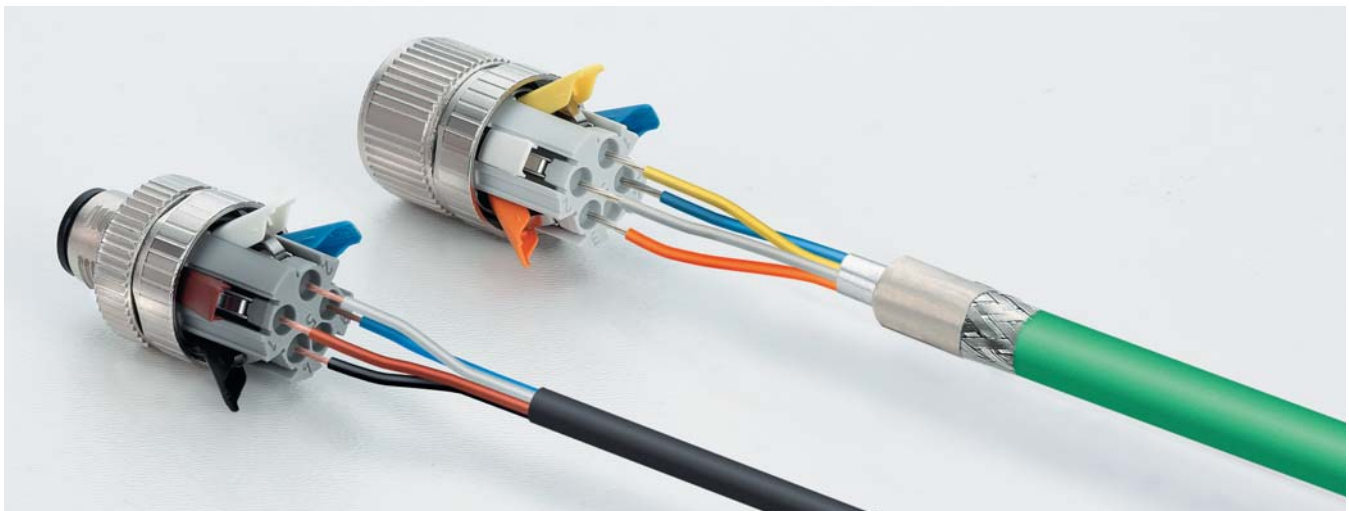

The LÜTZE M12 connectors with Push-In connection technology meet the needs of control cabinet, machine and equipment designers for safe, fault-free and therefore inexpensive wiring technology. Rigid conductors and conductors with ferrules can be wired quickly and without tools by direct insertion without having to first open the contact point. To connect the fire-wire strands without ferrules, the terminal point is opened by a coloured lever without tools, and then closed again.

Depending on the application, the LÜTZE M12 connectors are suitable for transferring signals, data and output, for shielded and unshielded applications. Thanks to the new Push-In-Technology, the insertion forces are very low which greatly simplifies the connection. In contrast, the pull-out forces are higher so that all connections guarantee a high level of wiring security. LÜTZE supplies the M12 connectors with Push-In-Technology for the same price as the screw terminal technology.

Improving the wiring efficiency

The LÜTZE Push-In-Technology makes full use of its benefits when prefabricated cables and cable harnesses are used. It can be operated intuitively and in only a few steps, whilst ensuring the highest contact security at the same time. LÜTZE uses a clear colour coding system for the wires during assembly. All colours in the connection block are assigned, for the actuator sensor area and for the field bus wiring such as CAN-Bus, Profibus, Ethernet and Profinet, according to the corresponding standards EN 60947-5-2. This means that firstly, it is almost impossible to confuse the PINS, and secondly there is no need for any more time-consuming and error-prone recoding of the individual colour codes. A permanent spring pushes each wire back so that even in the event of heavy vibration, and after numerous operating years with possible material fatigue in the copper wires, a constant pressure and therefore optimum, safe and uninterrupted contact is guaranteed.

The new M12 Push-In connectors by LÜTZE are available in various versions, either with a straight or angled connector, with the option of shielded or unshielded. The angled version allows the cable outlet to be positioned in 45° steps compared to the pole pattern. The LÜTZE M12 connectors with Push-In Technology have the same design as the screw terminal technology and are designed for more than 100 plug cycles.



Product Overview: Classification Ethernet Cables and Connectors

Ethernet cables

Art.no	Description	C-track compatible	Cat	Jacket	AWG						PROFINET	EtherCAT® / POWERLINK	SERCOS	CC-Link IE Field™	EtherNet/IP™			
					490128 - 490174	490151 AWG 27 - 22	490129 - 490175	490152 AWG 27 - 22	490138 - 490176	490153 AWG 26						490177 - 490178	AWG 27 - 22	490209, 490238
104301	Prof. (2X2XAWG22/1) UL		Type A	PVC														
104302	Prof. (2X2XAWG22/19) UL	•	Type C	PUR														
104303	Prof. (2X2XAWG22/7) UL	•	Type C	PUR														
104307	Prof. (2X2XAWG22/7) UL		Type B	PVC														
104331	Eth. (4X2XAWG26/7) UL		7	PVC														
104335	Eth. (4X2XAWG26/7) UL		5e	PVC														
104336	Eth. (4X2XAWG24/7) UL		5e	PVC	•	•												
104337	Eth. (4X2XAWG24/19) UL	•	5e	PUR	•	•												
104338	Eth. (4X2XAWG26/7) UL		6A	PVC														
104347	Eth. (4X2XAWG26/19) UL	•	6	PUR														
104350	Eth. (4X2XAWG22/7) UL		5e	PVC	•	•												
104379	Prof. (2X2XAWG26/19) UL	•	5e	PUR														
104396	Eth. (4X2XAWG26/19) UL	•	5e	PUR														
104397	Eth. (4X2XAWG22/1) UL		6A	PVC	•	•												
104401	Eth. (4X2XAWG24/7) UL	•	6A	PUR	•	•												
104404	Eth. (4x2xAWG24/7) UL	•	7	PUR	•	•												

Ethernet connector RJ45 / M12

RJ45 T568B			RJ45 T568A			RJ45 T568B AWG26		
490128 with cable clamp	490174 with cable fitting	490151 with cable fitting	490129 with cable clamp	490175 with cable fitting	490152 with cable fitting	490138 with cable clamp	490176 with cable fitting	490153 with cable fitting
1 white / orange			1 white / green			1 white / orange		
2 orange			2 green			2 orange		
3 white / green			3 white / orange			3 white / green		
4 blue			4 blue			4 blue		
5 white / blue			5 white / blue			5 white / blue		
6 green			6 orange			6 green		
7 white / brown			7 white / brown			7 white / brown		
8 brown			8 brown			8 brown		

RJ45 T568A/B		M12		Profinet RJ45	
490238 Module holder	490209 Module holder	490212 D-cod. pin	490213 D-cod. female	490167 X-cod. pin	490168 X-cod. female
		490214 D-cod. pin	490215 D-cod. female		
		1 yellow		1 white/orange	
		2 white		2 orange	
		3 orange		3 white / green	
		4 blue		4 green	
				5 white / brown	
				6 brown	
				7 white / blue	
				8 blue	

RJ45 T568A		RJ45 T568B	
1		1	
2		2	
3		3	
4		4	
5		5	
6		6	
7		7	
8		8	

Profinet RJ45	
1	
2	
3	
4	
5	
6	
7	
8	

Suppression Technology



Suppression technology



Suppressor for switch gear, universal suppressor module

Enclosure: S1, S2	127
Enclosure: V1	128
Enclosure: V2	129
Enclosure: S6 (SIEMENS, AEG, EATON)	130



Valve connector with cable

Valve connector Deutsch DT06-2S, with or without jacket	131 - 132
Valve connector AMP Junior Timer, with or without jacket	133 - 134
Design A (18 mm)	135 - 139
Design A (18 mm) with special function	140 - 142
Design B (10 mm)	143
Design BI (11 mm)	144
Design C (8 mm)	145
Design CI (9,4 mm)	146



Valve connector, adjustable

Design A (18 mm)	147
Design A (18 mm) with special function	148 - 149
Design BI (11 mm)	150
Design B (10 mm) and BI (11 mm) with special function	151



Valve suppression

Design A (18 mm)	152 - 153
Design BI (11 mm)	154



Motor suppression

Installation in the motor terminal board	155 - 158
For DIN rail mounting	159
Attachment to contactor	160
Mounting under contactor	161

Product photos

The product photos are not to scale and do not accurately depict every single product detail.

Suppression Technology - Suppressor for Switched Gear

Universal Suppressor Module

Enclosure type: S1, S2

Protection device: Diode / Varistor / RC module



Technical data

Type of function	Switching device suppression	Degree of protection	IP67
Type of connecting lead	0.5 mm ² LIY	Mounting	Attachment to contactor with holder
Cable length	0.15 m	Operation temperature range	DIN rail mounting
Connection type	Fork-type cable lug	Certifications	-20 °C ... +60 °C
Color of the housing	M 4		cURus (E135145)
	grey		

Part No.	Type	Conductor color	Rated voltage U _N	Cut-off peak V	Rated frequency f _N	Holding Capacity VA	Design	PU (units)
Diode								
700445	S* LD-S1-0445 DC 24-230V 1A	blue, red	DC 24–230 V	≤1		25	S1	10
700446	S* LD-S1-0446 DC 24-230V 3A	blue, red	DC 24–230 V	≤1		70	S1	10
Varistor								
700440	S* LV-S1-0440 AC/DC 24V 60VA	black	AC/DC 24 V	≤52	50 Hz / 60 Hz	60	S1	10
RC module								
700414	S* LRC-S2-0414 AC 230V 10VA	black	AC 115–230 V		50 Hz / 60 Hz	10	S2	10
700413	S* LRC-S2-0413 AC 230V 20VA	black	AC 115–230 V		50 Hz / 60 Hz	20	S2	10

Dimensions

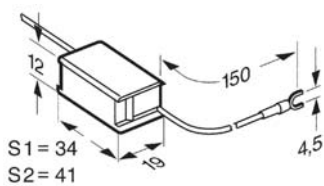

PIN assignment



PIN assignment

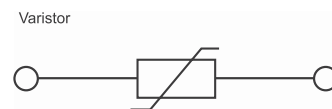

PIN assignment

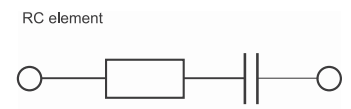

Suppression Technology - Suppressor for Switched Gear

Universal Suppressor Module

Enclosure type: V1

Protection device: Diode / Varistor / RC module

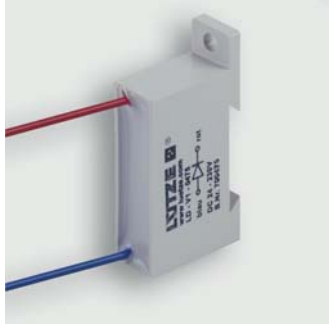

Technical data

Type of function
Type of connecting lead
Cable length
Connection type

Switching device suppression
0.5 mm² LIY
0.2 m
Fork-type cable lug
M 4
grey
IP67

Mounting

Dimensions (w × h × d)
Operation temperature range
Certifications

DIN rail mounting
1 snap-on socket
Attachment hole m 4
12.5 mm × 25.0 mm × 48.0 mm
-20 °C ... +60 °C

cURus (E135145)

Color of the housing
Degree of protection

Part No.	Type	Conductor color	Rated voltage U _N	Cut-off peak V	Rated frequency f _N	Holding Capacity VA	PU (units)
Diode							
700476	S* LD-V1-0476 DC 24-230V 3A	blue, red	DC 24–230 V	≤1		70	10
Varistor							
700577	S* LV-V1-0577 AC/DC 24V 200VA	black	AC/DC 24 V	≤52	50 Hz / 60 Hz	200	10
700568	A* LV-V1-0568 AC/DC 115V 200VA	black	AC/DC 115 V	≤250	50 Hz / 60 Hz	200	10
700435	S* LV-V1-0435 AC/DC 230V 200VA	black, blue	AC/DC 230 V	≤475	50 Hz / 60 Hz	200	10
RC module							
700466	S* LRC-V1-0466 AC 230V 30VA	black	AC 115–230 V		50 Hz / 60 Hz	30	10

Dimensions

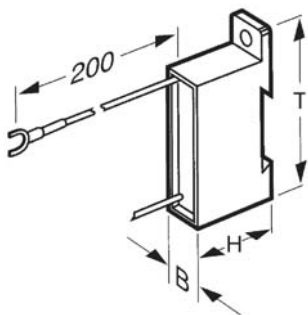

PIN assignment



PIN assignment

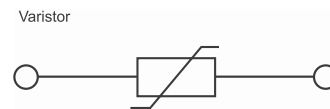

PIN assignment

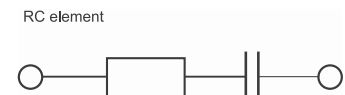

Suppression Technology - Suppressor for Switched Gear

Universal Suppressor Module
Enclosure type: V2
Protection device: RC module



Technical data

Type of function
 Type of connecting lead
 Cable length
 Connection type

Switching device suppression
 0.5 mm² LIY
 0.2 m
 Fork-type cable lug
 M 4
 grey
 IP67

Mounting

Dimensions (w × h × d)
 Operation temperature range
 Certifications

DIN rail mounting
 1 snap-on socket
 Attachment hole m 4
 15.0 mm × 30.0 mm × 58.0 mm
 -20 °C ... +60 °C

cURus (E135145)

Color of the housing
 Degree of protection

Part No.	Type	Conductor color	Rated voltage U _N	Rated frequency f _N	Holding Capacity VA	PU (units)
RC module						
700464	S* LRC-V2-0464 AC 400V 10VA	black	AC 230–400 V	50 Hz / 60 Hz	10	10
701583	S* LRC-V2-1583 AC 400V 60VA	black	AC 230–400 V	50 Hz / 60 Hz	60	10

Dimensions

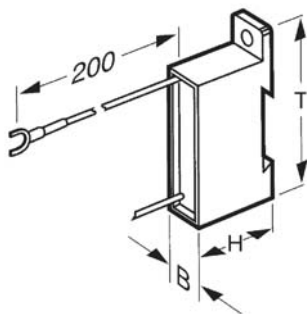

PIN assignment

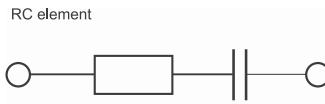

Suppression Technology - Suppressor for Switched Gear

Universal suppressor module - for Siemens-, AEG-, EATON contactors

Enclosure type S6

Protection device: Diode / Varistor / RC module



Technical data

Type of function
Type of connecting lead
Cable length
Connection type
Color of the housing

Switching device suppression
0.5 mm² LIY
0.15 m
Fork-type cable lug
M 4
grey

Degree of protection
Mounting
Dimensions (w × h × d)
Operation temperature range
Certifications

IP20
Attachment to contactor
32.5 mm × 27.0 mm × 11.5 mm
-20 °C ... +60 °C
cURus (E135145)

Part No.	Type	Conductor color	Rated voltage U _N	Cut-off peak V	Rated frequency f _N	Holding Capacity VA	PU (units)
Diode							
700323	S* LD-S6-0323 DC 24-230V 1A	blue, red	DC 24–230 V	≤1		25	10
Varistor							
700324	S* LV-S6-0324 AC/DC 24V 200VA	black	AC/DC 24 V	≤52	50 Hz / 60 Hz	200	10
RC module							
700321	S* LRC-S6-0321 AC 230V 10VA	black	AC 115–230 V		50 Hz / 60 Hz	10	10

PIN assignment

Diode



PIN assignment

Varistor



PIN assignment

RC element

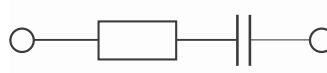

Suppression Technology - Valve suppressors Deutsch DT06-2S

With integrated protection device + LED

2pin version, protected against reverse polarity, moulded PUR connecting cable 2 × 0.75 mm²

On cable outlet can be directly mounted to a protective hose



Technical data

Type of function	Valve suppressor	Operation temperature range	Protective hose possible
Cut-off peak	≤52 V	Dimensions (w × h × d)	-30 °C ... +80 °C
Holding Capacity	100 VA	Pole number	14.9 mm × 17.1 mm × 49.5 mm
Type of connecting lead	2×0.75 mm ² PUR	Mechanical service life	2
Status indication	LED yellow	Comments	>100 insertion cycles
Jacket color	black		Very good chemical and oil resistance.
Color of the housing	translucent black		The material resistance must be checked
Degree of protection	IP67		based on the application for use with
Mounting	plug-in		aggressive media!

Part No.	Type	Cable length m	Rated voltage U _N	Amperage range A	PU (units)
Suppressor diode + LED					
709442.0250	S* LS-DT06 9442.0250	2,5mPUR 2.5	DC 12/24 V	≤2	1
709442.0500	S* LS-DT06 9442.0500	5,0mPUR 5.0	DC 12/24 V	≤2	1
709442.0750	S* LS-DT06 9442.0750	7,5mPUR 7.5	DC 12/24 V	≤2	1
709442.1000	S* LS-DT06 9442.1000	10mPUR 10.0	DC 12/24 V	≤2	1
709442.1500	S* LS-DT06 9442.1500	15mPUR 15.0	DC 12/24 V	≤2	1
709442.2000	A* LS-DT06 9442.2000	20mPUR 20.0	DC 12/24 V	≤2	100

Dimensions

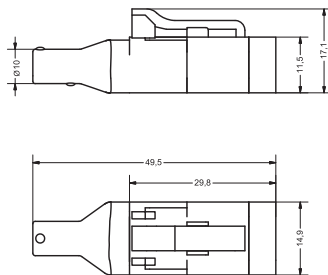

PIN assignment

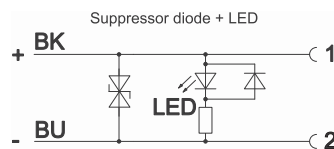

Pin layout

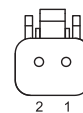

Suppression Technology - Valve suppressors, Deutsch DT06-2S - outdoor

With integrated protection device + LED

Protection against reverse polarity, moulded single conductor PVC FLRY 2 × 0.75 mm²

On cable outlet can be directly mounted to a protective hose



Technical data

Type of function	Valve suppressor	Operation temperature range	Protective hose possible
Cut-off peak	≤52 V	Dimensions (w × h × d)	-30 °C ... +80 °C
Holding Capacity	100 VA	Pole number	14.9 mm × 17.1 mm × 49.5 mm
Type of connecting lead	2×0.75 mm ² FLRY	Mechanical service life	2
Status indication	LED yellow	Comments	>100 insertion cycles
Color of the housing	translucent black		Very good chemical and oil resistance.
Degree of protection	IP67		The material resistance must be checked based on the application for use with aggressive media!
Mounting	plug-in		

Part No.	Type	Cable length m	Rated voltage U _N	Amperage range A	PU (units)
Suppressor diode + LED					
709441.0250	A* LS-DT06-9441.0250 2,5m FLRY	2.5	DC 12/24 V	≤2	100
709441.0500	A* LS-DT06 9441.0500 5,0m FLRY	5.0	DC 12/24 V	≤2	100
709441.0750	S* LS-DT06 9441.0750 7,5m FLRY	7.5	DC 12/24 V	≤2	100
709441.1000	S* LS-DT06 9441.1000 10,0m FLRY	10.0	DC 12/24 V	≤2	100
709441.1500	S* LS-DT06 9441.1500 15m FLRY	15.0	DC 12/24 V	≤2	100
709441.2000	A* LS-DT06 9441.2000 20,0m FLRY	20.0	DC 12/24 V	≤2	100

Dimensions

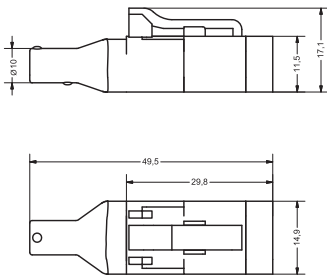

PIN assignment

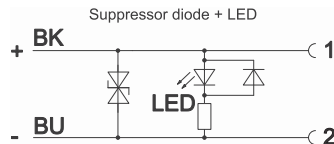

Pin layout

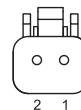

Suppression Technology - Valve suppressors AMP Junior Timer

With integrated protection device + LED
 2-pin style, protection against reverse polarity
 Moulded PUR connecting cable 2 × 0.75 mm²



Technical data

Type of function
 Protection device
 Cut-off peak
 Holding Capacity
 Type of connecting lead
 Status indication
 Jacket color
 Color of the housing

Valve suppressor
 Suppressor diode + LED
 ≤75 V
 100 VA
 2×0.75 mm² PUR
 LED yellow
 black
 black

Degree of protection
 Mounting
 Operation temperature range
 Pole number
 Mechanical service life
 Comments

IP65
 plug-in
 -25 °C ... +80 °C
 2
 >100 insertion cycles
 Very good chemical and oil resistance.
 The material resistance must be checked
 based on the application for use with
 aggressive media!

Part No.	Type	Design	Cable length m	Rated voltage U _N	Amperage range A	PU (units)
Suppressor diode + LED						
709482	S*	LS-AMP 9482 2,5m PUR straight	2.5	AC/DC 24 V	≤4	1
709483	S*	LS-AMP 9483 5m PUR straight	5.0	AC/DC 24 V	≤4	1
709484	S*	LS-AMP 9484 7,5m PUR straight	7.5	AC/DC 24 V	≤4	1
709485	S*	LS-AMP 9485 10m PUR straight	10.0	AC/DC 24 V	≤4	1
709486	S*	LS-AMP 9486 15m PUR straight	15.0	AC/DC 24 V	≤4	1
709487	R*	LS-AMP 9487 20m PUR straight	20.0	AC/DC 24 V	≤4	100
709472	S*	LS-AMP 9472 2,5m PUR angle connector	2.5	AC/DC 24 V	≤4	1
709473	R*	LS-AMP 9473 5m PUR angle connector	5.0	AC/DC 24 V	≤4	100
709474	R*	LS-AMP 474 7,5m PUR angle connector	7.5	AC/DC 24 V	≤4	100
709475	R*	LS-AMP 475 10m PUR angle connector	10.0	AC/DC 24 V	≤4	100
709476	R*	LS-AMP 9476 15m PUR angle connector	15.0	AC/DC 24 V	≤4	100
709477	R*	LS-AMP 9477 20m PUR angle connector	20.0	AC/DC 24 V	≤4	100

Dimensions

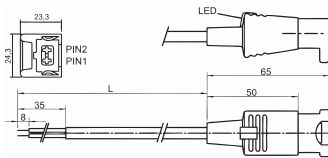

Dimensions

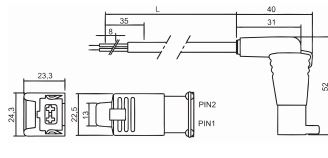

PIN assignment

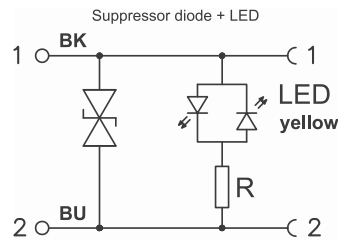

Suppression Technology - AMP Junior Timer Connector

2-pole straight

Protection device suppressor diode + status indication LED

With moulded vehicle cable Type FLRY as single conductor 0.75 mm²



Technical data

Type of function	Valve suppressor
Cut-off peak	≤75 V
Holding Capacity	100 VA
Type of connecting lead	2×0.75 mm ² FLRY
Status indication	LED yellow
Color of the housing	black
Degree of protection	IP65

Operation temperature range	-25 °C ... +80 °C
Dimensions (w × h × d)	24.3 mm × 22.3 mm × 65.0 mm
Pole number	2
Mechanical service life	>100 insertion cycles
Comments	Very good chemical and oil resistance. The material resistance must be checked based on the application for use with aggressive media!

Operation temperature range	-25 °C ... +80 °C
Dimensions (w × h × d)	24.3 mm × 22.3 mm × 65.0 mm
Pole number	2
Mechanical service life	>100 insertion cycles
Comments	Very good chemical and oil resistance. The material resistance must be checked based on the application for use with aggressive media!

Part No.	Type	Cable length m	Rated voltage U _N	Amperage range A	PU (units)
Suppressor diode + LED					
709443.0250	A* LS-AMP 9443.0250 2,5m PVC	2.5	AC/DC 18–30 V	≤4	100
709443.0500	A* LS-AMP 9443.0500 5,0m PVC	5.0	AC/DC 18–30 V	≤4	100
709443.0750	A* LS-AMP 9443.0750 7,5m PVC	7.5	AC/DC 18–30 V	≤4	100
709443.1000	A* LS-AMP 9443.1000 10m PVC	10.0	AC/DC 18–30 V	≤4	100
709443.1500	A* LS-AMP 9443.1500 15m PVC	15.0	AC/DC 18–30 V	≤4	100
709443.2000	R* LS-AMP 9443.2000 20m PVC	20.0	AC/DC 18–30 V	≤4	100

Dimensions

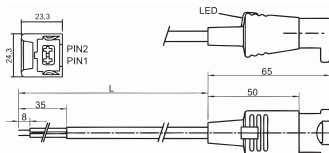

PIN assignment

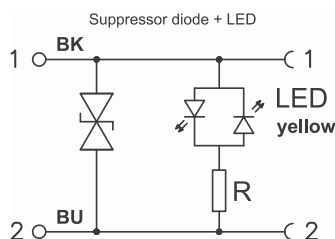

Suppression Technology - Valve suppressors

Design A (18 mm), 2-pin without PE

Protection device suppressor diode + LED, with stainless steel screw

Moulded PUR connecting cable 2 × 0.75 mm², 0°/180° mounting possible



Technical data

Type of function	Valve suppressor
Cut-off peak	≤52 V
Holding Capacity	100 VA
Type of connecting lead	2×0.75 mm ² PUR
Status indication	LED yellow
Jacket color	black
Color of the housing	transparent
Degree of protection	IP67
Mounting	Breakaway torque 0.4 Nm
Operation temperature range	Protective hose possible -25 °C ... +80 °C

Dimensions (w × h × d)

Pole number	2
Mechanical service life	>100 insertion cycles
Standards	EN 175301-803 ISO 4400

Accessories

Comments

Tag holder 7x20 mm, white: Part-No. 760968 | BZT-0720 | PU: 100 units
Very good chemical and oil resistance. The material resistance must be checked based on the application for use with aggressive media!

Part No.	Type	Cable length m	Rated voltage U _N	Amperage range A	PU (units)
Suppressor diode + LED					
709469	S* LS-A-9469 1,0mPUR AC/DC 24V	1.0	AC/DC 12–24 V	≤4	1
709459	S* LS-A-9459 2,5mPUR AC/DC 24V	2.5	AC/DC 12–24 V	≤4	1
709460	S* LS-A-9460 5,0mPUR AC/DC 24V	5.0	AC/DC 12–24 V	≤4	1
709462	S* LS-A-9462 10mPUR AC/DC 24V	10.0	AC/DC 12–24 V	≤4	1

Dimensions

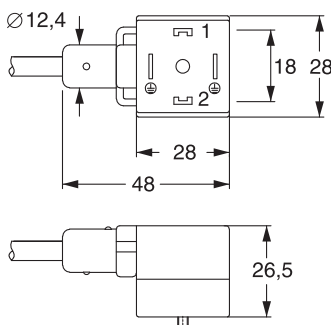

PIN assignment

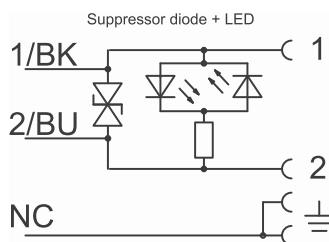

Suppression Technology - Valve suppressors

Design A (18 mm), 2-pin without PE

Protection device suppressor diode + LED, with stainless steel screw

Moulded vehicle cable Type FLRY single conductor 2x0.75mm², 0°/180° mounting possible

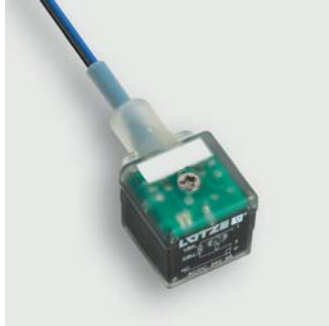

Technical data

Type of function	Valve suppressor
Cut-off peak	≤52 V
Holding Capacity	100 VA
Type of connecting lead	2x0.75 mm ² FLRY
Status indication	LED yellow
Color of the housing	transparent
Fixing	Fixing screw stainless steel 1.4567
Degree of protection	IP65
Mounting	Breakaway torque 0.4 Nm
Operation temperature range	Protective hose possible -25 °C ... +90 °C

Dimensions (w × h × d)
Pole number
Mechanical service life
Standards

28.0 mm × 26.5 mm × 48.0 mm
2
>100 insertion cycles
EN 175301-803
ISO 4400

Accessories

Comments

Tag holder 7x20 mm, white: Part-No. 760968 | BZT-0720 | PU: 100 units
Very good chemical and oil resistance. The material resistance must be checked based on the application for use with aggressive media!

Part No.	Type	Cable length m	Rated voltage U _N	Amperage range A	PU (units)
Suppressor diode + LED					
709428.0500	A* LS-A 5,0 m FLRY AC/DC 12-24 V	5.0	AC/DC 12–24 V	≤7	100
709428.0250	A* LS-A 2,5 m FLRY AC/DC 12-24 V	2.5	AC/DC 12–24 V	≤7	100
709428.0750	A* LS-A 10m FLRY AC/DC 12-24 V	7.5	AC/DC 12–24 V	≤7	100
709428.1000	A* LS-A 10m FLRY AC/DC 12-24 V	10.0	AC/DC 12–24 V	≤7	100
709428.1500	A* LS-A 15m FLRY AC/DC 12-24 V	15.0	AC/DC 12–24 V	≤7	100
709428.2000	A* LS-A 20m FLRY AC/DC 12-24 V	20.0	AC/DC 12–24 V	≤7	100

Dimensions

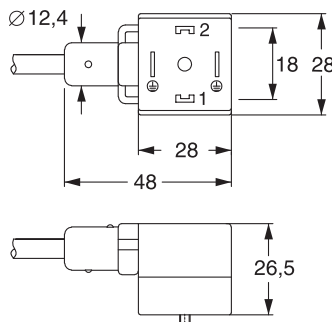

PIN assignment

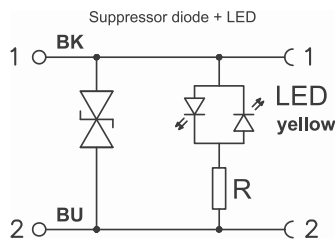

Suppression Technology - Valve suppressors

Design A (18mm), 3-pin without PE, 0°

Without circuit, with stainless steel screw

With moulded vehicle cable Type FLRY single conductor 3x0.75mm²



Technical data

Type of function: Valve suppressor
 Holding Capacity: 100 VA
 Type of connecting lead: 0.75 mm² FLRY
 Color of the housing: black
 Fixing: Fixing screw stainless steel 1.4567
 Degree of protection: IP65
 Mounting: Breakaway torque 0.4 Nm
 Protective hose possible
 Operation temperature range: -25 °C ... +90 °C

Dimensions (w × h × d)
 Pole number
 Mechanical service life
 Standards

28.0 mm × 26.5 mm × 48.0 mm

3
 >100 insertion cycles
 EN 175301-803
 ISO 4400

Comments

Very good chemical and oil resistance.
 The material resistance must be checked based on the application for use with aggressive media!

Part No.	Type	Cable length m	Rated voltage U _N	Amperage range A	PU (units)
None protection device					
709427.0250	A* L-A 2,5 m FLRY 0° AC/DC 0-230 V	2.5	AC/DC 0-230 V	≤7	100
709427.0500	A* L-A 5,0 m FLRY 0° AC/DC 0-230 V	5.0	AC/DC 0-230 V	≤7	100
709427.0750	A* L-A 7,5 m FLRY 0° AC/DC 0-230 V	7.5	AC/DC 0-230 V	≤7	100
709427.1000	A* L-A 10m FLRY 0° AC/DC 0-230 V	10.0	AC/DC 0-230 V	≤7	100
709427.1500	A* L-A 10m FLRY 0° AC/DC 0-230 V	15.0	AC/DC 0-230 V	≤7	100
709427.2000	A* L-A 10m FLRY 0° AC/DC 0-230 V	20.0	AC/DC 0-230 V	≤7	100

Dimensions

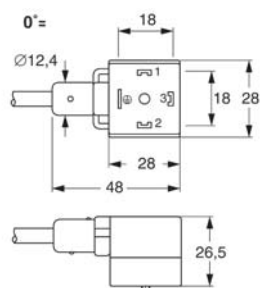

PIN assignment

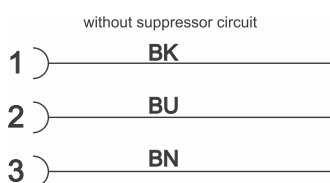

Suppression Technology - Valve suppressors

Design A (18mm), 2-pin + 2×PE

PVC connecting lead 3×0,5mm²

With bridged ground conductor (PE), 0°/180° mounting possible



Technical data

Type of function	Valve suppressor
Type of connecting lead	3×0,5 mm ² PVC
Jacket color	black
Degree of protection	IP67
Mounting	Breakaway torque 0.4 Nm Protective hose possible
Operation temperature range	-25 °C ... +80 °C
Pole number	3
Dimensions (w × h × d)	28.0 mm × 26.5 mm × 48.0 mm

Mechanical service life
Standards

>100 insertion cycles
EN 175301-803
ISO 4400

Accessories

Comments

Tag holder 7×20 mm, white: Part-No. 760968 | BZT-0720 | PU: 100 units
Very good chemical and oil resistance. The material resistance must be checked based on the application for use with aggressive media!

Part No.	Type	Cable length m	Rated voltage U _N	Amperage range A	Cut-off peak V	Status indication	Color of the housing	PU (units)
None protection device								
709600	S* L-A-9600 2,5mPVC up to 230 V	2.5	AC/DC 0–230 V	≤7			black	1
709601	S* L-A-9601 5mPVC up to 230 V	5.0	AC/DC 0–230 V	≤7			black	1
709608	S* L-A-9608 10m PVC 0-230V	10.0	AC/DC 0–230 V	≤7			black	1
Suppressor diode + LED								
709605	S* LS-A-9605 2.5m PVC 24V	2.5	AC/DC 24 V	≤4	≤52	LED yellow	transparent	1
709606	S* LS-A-9606 5m PVC 24V	5.0	AC/DC 24 V	≤4	≤52	LED yellow	transparent	1
709607	S* LS-A-9607 10m PVC 24V	10.0	AC/DC 24 V	≤4	≤52	LED yellow	transparent	1
Varistor + LED								
709673	S* LV-A-9673 2.5m PVC 230V	2.5	AC/DC 230 V	≤0.5	≤475	LED yellow	transparent	1
709674	S* LV-A-9674 5m PVC 230V	5.0	AC/DC 230 V	≤0.5	≤475	LED yellow	transparent	1
709675	S* LV-A-9675 10m PVC 230V	10.0	AC/DC 230 V	≤0.5	≤475	LED yellow	transparent	1

Dimensions

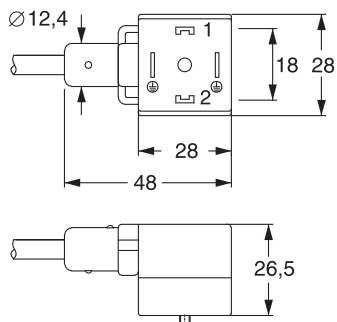

PIN assignment

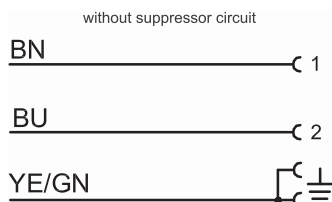

PIN assignment

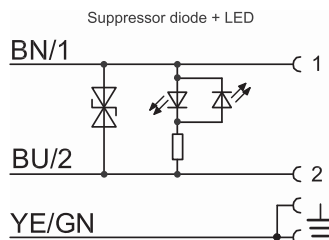

PIN assignment

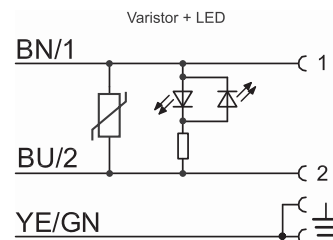

Suppression Technology - Valve suppressors

Design A (18mm), 2-pin + 2×PE

PUR connecting lead 3×0,5mm²

With bridged ground conductor (PE), 0°/180° mounting possible



Technical data

Type of function
Type of connecting lead
Jacket color
Degree of protection
Mounting

Operation temperature range
Pole number
Dimensions (w × h × d)

Valve suppressor
3×0.5 mm² PUR
black
IP67
Breakaway torque 0.4 Nm
Protective hose possible
-25 °C ... +80 °C
3
28.0 mm × 26.5 mm × 48.0 mm

Mechanical service life
Standards

Accessories

Comments

>100 insertion cycles
EN 175301-803
ISO 4400

Tag holder 7×20 mm, white: Part-No. 760968 | BZT-0720 | PU: 100 units
Very good chemical and oil resistance.
The material resistance must be checked based on the application for use with aggressive media!

Part No.	Type	Cable length m	Rated voltage U _N	Amperage range A	Cut-off peak V	Status indication	Color of the housing	PU (units)
None protection device								
709700	A* L-A-9700 2,5mPUR up to 230 V	2.5	AC/DC 0–230 V	≤7			black	100
709701	A* L-A-9701 5mPUR up to 230 V	5.0	AC/DC 0–230 V	≤7			black	100
709708	A* L-A-9708 10m PUR 0-230V	10.0	AC/DC 0–230 V	≤7			black	100
Diode + LED								
709526	A* LD-A-9526 2,0m PUR 24V	2.5	DC 24 V	≤4	≤1	LED yellow	transparent	100
709527	A* LD-A-9527 5,0m PUR 24V	5.0	DC 24 V	≤4	≤1	LED yellow	transparent	100
Suppressor diode + LED								
709705	S* LS-A-9705 2.5m PUR 24V	2.5	AC/DC 24 V	≤4	≤52	LED yellow	transparent	1
709706	S* LS-A-9706 5m PUR 24V	5.0	AC/DC 24 V	≤4	≤52	LED yellow	transparent	1
709707	S* LS-A-9707 10m PUR 24V	10.0	AC/DC 24 V	≤4	≤52	LED yellow	transparent	1
Varistor + LED								
709773	S* LV-A-9773 2.5m PUR 230V	2.5	AC/DC 230 V	≤0.5	≤475	LED yellow	transparent	1
709774	S* LV-A-9774 5m PUR 230V	5.0	AC/DC 230 V	≤0.5	≤475	LED yellow	transparent	1
709775	S* LV-A-9775 10m PUR 230V	10.0	AC/DC 230 V	≤0.5	≤475	LED yellow	transparent	1

Dimensions

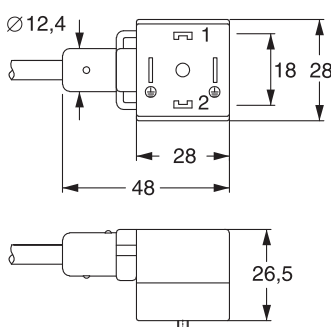

PIN assignment

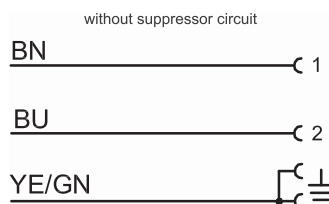

PIN assignment

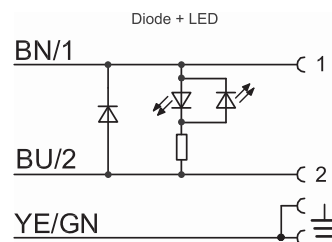

PIN assignment

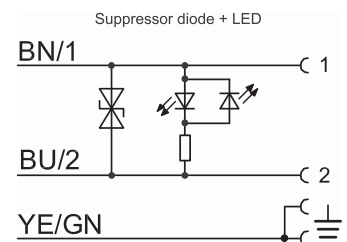

Suppression Technology - Valve Suppressors - special function

Energy reducer, construction A (18 mm), PUR cable 3x0,5mm²

Energy reduction approx. 50 %, protection device, LED status indication

Open cable end, 0°/180° mounting possible



Technical data

Type of function	Energy reducer
Switching frequency	Max. 2 Hz
Energy reduction	Reduction factor approx. 50 %
Cut-off peak	≤1 V
Holding Capacity	50 VA
Type of connecting lead	3x0.5 mm ² PUR
Status indication	LED yellow
Conductor insulation	PVC
Jacket color	black
Color of the housing	translucent black
Degree of protection	IP67
Mounting	Breakaway torque 0.4 Nm

Operation temperature range	-25 °C ... +80 °C
Dimensions (w × h × d)	22.0 mm × 26.5 mm × 50.0 mm
Pole number	3
Mechanical service life	>100 insertion cycles
Standards	EN 175301-803 ISO 4400

Accessories

Comments

Protective hose possible	-25 °C ... +80 °C
Dimensions (w × h × d)	22.0 mm × 26.5 mm × 50.0 mm
Pole number	3
Mechanical service life	>100 insertion cycles
Standards	EN 175301-803 ISO 4400

Tag holder 7x20 mm, white: Part-No. 760968 | BZT-0720 | PU: 100 units
Very good chemical and oil resistance. The material resistance must be checked based on the application for use with aggressive media!

Part No.	Type	Cable length m	Rated voltage U _N	Amperage range A	PU (units)
Energy reducer					
709709.0250	S* LER-A-9709 2,5m PUR DC 24V	2.5	DC 24 V	≤2	1
709709.0500	S* LER-A-9709 5,0m PUR DC 24V	5.0	DC 24 V	≤2	1
709709.1000	S* LER-A-9709 10m PUR DC 24V	10.0	DC 24 V	≤2	1

Dimensions

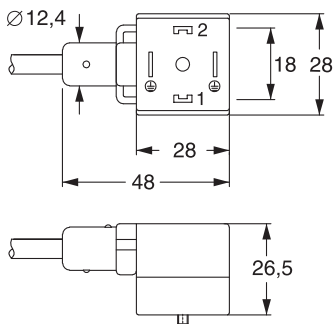

PIN assignment

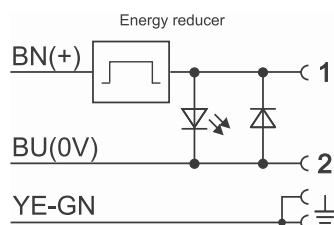

Suppression Technology - Valve Suppressors - special function

Design A (18mm), 3-pin + 1xPE
PUR connecting lead 5x0,5mm²
Pressure switch / fill level monitor



Technical data

Type of function
 Type of connecting lead
 Status indication
 Jacket color
 Color of the housing
 Degree of protection
 Mounting

Operation temperature range
 Dimensions (w × h × d)

Pressure switch
 5x0.5 mm² PUR
 LED yellow + LED green
 black
 transparent
 IP67
 Breakaway torque 0.4 Nm
 Protective hose possible
 -25 °C ... +80 °C
 28.0 mm × 26.5 mm × 48.0 mm

Connection type
 Pole number
 Mechanical service life
 Standards

Accessories

Comments

0°, PE at the entry point

4
 >100 insertion cycles
 EN 175301-803
 ISO 4400

Tag holder 7x20 mm, white: Part-No. 760968 | BZT-0720 | PU: 100 units
 Very good chemical and oil resistance.
 The material resistance must be checked based on the application for use with aggressive media!

Part No.	Type	Cable length m	Rated voltage U _N	Amperage range A	PU (units)
0°, PE at the entry point					
709772	S* LDS-A-9772 5m PUR DC 24V	5.0	DC 24 V	≤4	1
709771	S* LDS-A-9771 10m PUR DC 24V	10.0	DC 24 V	≤4	1
180°, PE across from the cable entry point					
709782	S* LDS-A-9782 5m PUR DC 24V	5.0	DC 24 V	≤4	1
709789	A* LDS-A-9789 10m PUR DC 24V	10.0	DC 24 V	≤4	1

Dimensions

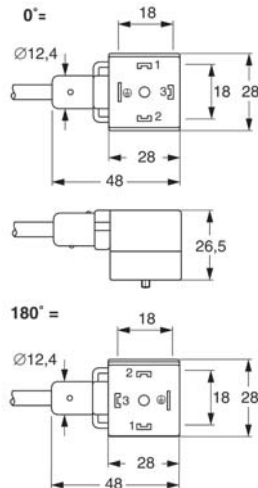

PIN assignment

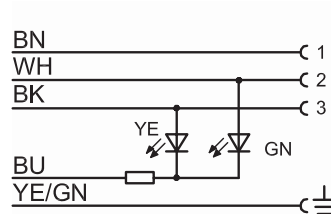

Suppression Technology - Valve Suppressors - special function

Design A (18mm), 2-pin + 2×PE

PUR connecting lead 4×0,75mm²

Switching amplifier, short-circuit-proof, 0°/180° mounting possible



Technical data

Type of function	Switching amplifier
Switching frequency	Max. 20 Hz
Switch-on delay	<100 µs
Switch-off delay	<200 µs
Cut-off peak	≤52 V
Holding Capacity	100 VA
Type of connecting lead	4×0.75 mm ² PUR
Short-circuit protection	Short circuit protected
Status indication	LED yellow
Jacket color	black
Color of the housing	transparent
Degree of protection	IP67
Mounting	Breakaway torque 0.4 Nm

Operation temperature range	-25 °C ... +80 °C
Dimensions (w × h × d)	28.0 mm × 26.5 mm × 48.0 mm
Pole number	3
Mechanical service life	>100 insertion cycles
Standards	EN 175301-803 ISO 4400

Accessories

Comments

Protective hose possible

-25 °C ... +80 °C
28.0 mm × 26.5 mm × 48.0 mm
3
>100 insertion cycles
EN 175301-803
ISO 4400

Tag holder 7×20 mm, white: Part-No. 760968 | BZT-0720 | PU: 100 units
Very good chemical and oil resistance.
The material resistance must be checked based on the application for use with aggressive media!

Part No.	Type	Cable length m	Rated voltage U _N	Amperage range A	PU (units)
Switching amplifier					
709790	S* LVER-A-9790 2,5m PUR DC 24V	2.5	DC 24 V	≤2	1
709791	S* LVER-A-9791 5m PUR DC 24V	5.0	DC 24 V	≤2	1
709792	S* LVER-A-9792 10m PUR DC 24V	10.0	DC 24 V	≤2	1

Dimensions

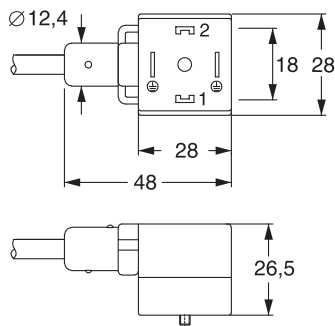

PIN assignment

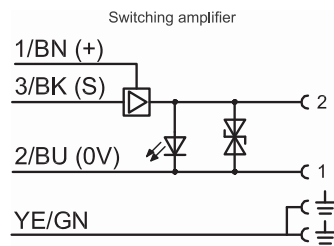

Suppression Technology - Valve suppressors

Design B (10mm), 2pol. + 1×PE

PUR connecting lead 3×0,5mm²

Protection device: suppressor diode + LED



Technical data

Type of function Valve suppressor
 Cut-off peak ≤52 V
 Holding Capacity 100 VA
 Type of connecting lead 3×0.5 mm² PUR
 Status indication LED yellow
 Jacket color black
 Color of the housing transparent
 Degree of protection IP67
 Mounting Breakaway torque 0.4 Nm
 Protective hose possible
 Operation temperature range -25 °C ... +80 °C

Dimensions (w × h × d)

Pole number 3
 Mechanical service life >100 insertion cycles
 Standards EN 175301-803
 ISO 6952

Accessories

Comments

Tag holder 7×20 mm, white: Part-No. 760968 | BZT-0720 | PU: 100 units
 Very good chemical and oil resistance.
 The material resistance must be checked based on the application for use with aggressive media!

Part No.	Type	Cable length m	Rated voltage U _N	Amperage range A	PU (units)
Suppressor diode + LED					
709715	S* LS-B-9715 2.5m PUR 0° 24V	2.5	AC/DC 24 V	≤4	1
709716	S* LS-B-9716 5m PUR 0° 24V	5.0	AC/DC 24 V	≤4	1
709717	S* LS-B-9717 10m PUR 0° 24V	10.0	AC/DC 24 V	≤4	1
709725	S* LS-B-9725 2.5m PUR 180° 24V	2.5	AC/DC 24 V	≤4	1
709726	S* LS-B-9726 5m PUR 180° 24V	5.0	AC/DC 24 V	≤4	1
709727	S* LS-B-9727 10m PUR 180° 24V	10.0	AC/DC 24 V	≤4	1

Dimensions

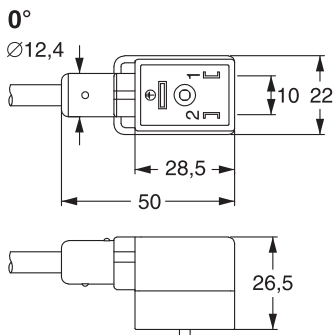

PIN assignment

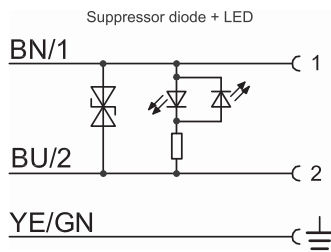

Suppression Technology - Valve suppressors

Design BI (11mm), 2pol. + 1×PE

PUR/PVC connecting lead 3×0,5mm²

Protection device: suppressor diode + LED



Technical data

Type of function
Cut-off peak
Holding Capacity
Status indication
Jacket color
Color of the housing
Degree of protection
Mounting

Valve suppressor
≤52 V
100 VA
LED yellow
black
transparent
IP67
Breakaway torque 0.4 Nm
Protective hose possible

Operation temperature range
Dimensions (w × h × d)
Pole number
Mechanical service life
Accessories

Comments

-25 °C ... +80 °C
22.0 mm × 26.5 mm × 50.0 mm
3
>100 insertion cycles
Tag holder 7×20 mm, white: Part-No. 760968 | BZT-0720 | PU: 100 units
Very good chemical and oil resistance.
The material resistance must be checked based on the application for use with aggressive media!

Part No.	Type	Cable length m	Rated voltage U _N	Amperage range A	PU (units)
Suppressor diode + LED					
709635	S* LS-BI-9635 2,5m PVC 0° 24 V	2.5	AC/DC 24 V	≤4	1
709636	S* LS-BI-9636 5m PVC 0° 24V	5.0	AC/DC 24 V	≤4	1
709637	S* LS-BI-9637 10m PVC 0° 24V	10.0	AC/DC 24 V	≤4	1
709645	S* LS-BI-9645 2.5m PVC 180° 24V	2.5	AC/DC 24 V	≤4	1
709646	S* LS-BI-9646 5m PVC 180° 24V	5.0	AC/DC 24 V	≤4	1
709647	S* LS-BI-9647 10m PVC 180° 24V	10.0	AC/DC 24 V	≤4	1
709735	S* LS-BI-9735 2.5m PUR 0° 24V	2.5	AC/DC 24 V	≤4	1
709736	S* LS-BI-9736 5m PUR 0° 24V	5.0	AC/DC 24 V	≤4	1
709737	S* LS-BI-9737 10m PUR 0° 24V	10.0	AC/DC 24 V	≤4	1
709745	S* LS-BI-9745 2.5m PUR 180° 24V	2.5	AC/DC 24 V	≤4	1
709746	S* LS-BI-9746 5m PUR 180° 24V	5.0	AC/DC 24 V	≤4	1
709747	S* LS-BI-9747 10m PUR 180° 24V	10.0	AC/DC 24 V	≤4	1

Dimensions

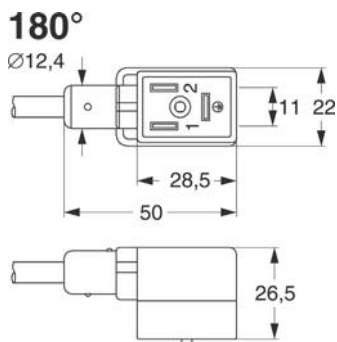

Dimensions

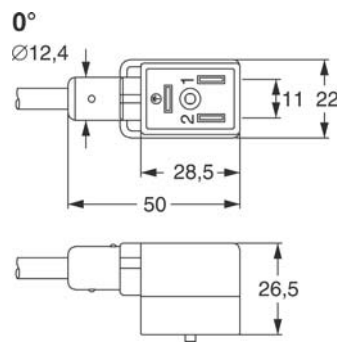

PIN assignment

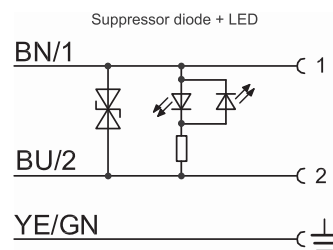

Suppression Technology - Valve suppressors

Design C (8mm), 2-pin + 2xPE
PUR/PVC connecting lead 3x0,5mm²
with bridged ground conductor (PE)



Technical data

Type of function	Valve suppressor
Cut-off peak	≤52 V
Holding Capacity	70 VA
Status indication	LED yellow
Jacket color	black
Color of the housing	transparent
Degree of protection	IP67
Mounting	Breakaway torque 0.4 Nm
Operation temperature range	Protective hose possible -25 °C ... +80 °C

Dimensions (w × h × d)
 Pole number
 Mechanical service life
 Standards

16.0 mm × 25.3 mm × 39.0 mm
 3
 >100 insertion cycles
 EN 175301-803
 ISO 6952

Accessories

Comments

Tag holder 7x20 mm, white: Part-No. 760968 | BZT-0720 | PU: 100 units
 Very good chemical and oil resistance.
 The material resistance must be checked based on the application for use with aggressive media!

Part No.	Type	Cable length m	Rated voltage U _N	Amperage range A	PU (units)
Suppressor diode + LED					
709653	S* LS-C-9653 2.5m PVC 24V	2.5	AC/DC 24 V	≤3	1
709654	S* LS-C-9654 5m PVC 24V	5.0	AC/DC 24 V	≤3	1
709659	S* LS-C-9659 10m PVC 24V	10.0	AC/DC 24 V	≤3	1
709753	S* LS-C-9753 2.5m PUR 24V	2.5	AC/DC 24 V	≤3	1
709754	S* LS-C-9754 5m PUR 24V	5.0	AC/DC 24 V	≤3	1
709759	S* LS-C-9759 10m PUR 24V	10.0	AC/DC 24 V	≤3	1

Dimensions

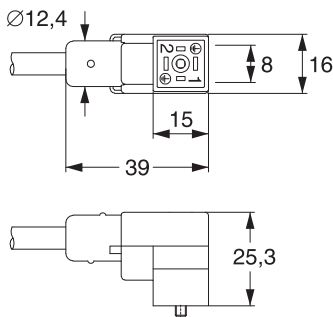

PIN assignment

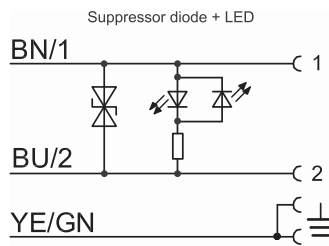

Suppression Technology - Valve suppressors

Design CI (9,4mm), 2pol. + 2xPE

PUR/PVC connecting lead 3x0,5mm²

with bridged ground conductor (PE), 0°/180° mounting possible



Technical data

Type of function
Cut-off peak
Holding Capacity
Status indication
Jacket color
Color of the housing
Degree of protection
Mounting

Valve suppressor
≤52 V
70 VA
LED yellow
black
transparent
IP67
Breakaway torque 0.4 Nm
Protective hose possible

Operation temperature range
Dimensions (w × h × d)
Pole number
Mechanical service life
Accessories

Comments

-25 °C ... +80 °C
16.0 mm × 25.3 mm × 39.0 mm
3
>100 insertion cycles
Tag holder 7x20 mm, white: Part-No. 760968 | BZT-0720 | PU: 100 units
Very good chemical and oil resistance.
The material resistance must be checked based on the application for use with aggressive media!

Part No.	Type	Cable length m	Rated voltage U _N	Amperage range A	PU (units)
Suppressor diode + LED					
709666	S* LS-CI-9666 2.5m PVC 24V	2.5	AC/DC 24 V	≤3	1
709667	S* LS-CI-9667 5m PVC 24V	5.0	AC/DC 24 V	≤3	1
709668	S* LS-CI-9668 10m PVC 24V	10.0	AC/DC 24 V	≤3	1
709766	A* LS-CI-9766 2.5m PUR 24V	2.5	AC/DC 24 V	≤3	100
709767	A* LS-CI-9767 5m PUR 24V	5.0	AC/DC 24 V	≤3	100
709768	S* LS-CI-9768 10m PUR 24V	10.0	AC/DC 24 V	≤3	1

Dimensions

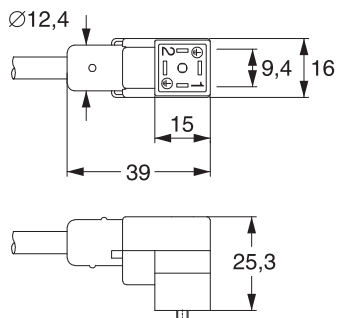

PIN assignment

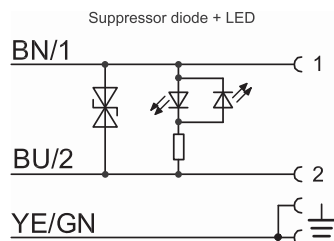

Suppression Technology - Valve suppressors

Adjustable male, design A (18 mm), IP67

Ground wire terminator (PE) adjustable in 90° steps

Protection device: without circuit / Z-Diode+LED / Varistor+LED



Technical data

Type of function
Degree of protection
Mounting
Operation temperature range
Dimensions (w × h × d)

Valve suppressor
IP67
Breakaway torque 0.4 Nm
-40 °C ... +90 °C
26.8 mm × 28.8 mm × 50.0 mm

Connection type
Connection cross-section
Connection cross-section
Mechanical service life
Certifications

Screw terminal
max. 1.5 mm²
max. AWG 16
>100 insertion cycles

cURus (E256031)

Part No.	Type	Rated voltage U _N	Amperage range A	Connecting lead Ø	Color of the housing	Pole number	Design	PU (units)
None protection device								
705800	S* L-V20-5800 AC/ DC 0-230V	AC/DC 0-230 V	≤10	4 – 9 mm	black	2	A (18 mm)	1
705801	S* L-V20-5801 AC/ DC 0-230V	AC/DC 0-230 V	≤10	4 – 9 mm	black	3	A (18 mm)	1
Suppressor diode + LED								
705810	S* LS-V20-5810 AC/DC 24V	AC/DC 24 V	≤4	4 – 9 mm	transparent	2	A (18 mm)	1
Varistor + LED								
705830	S* LV-V20-5830 AC/ DC 110-230V	AC/DC 110-230 V	≤1	4 – 9 mm	transparent	2	A (18 mm)	1

Dimensions

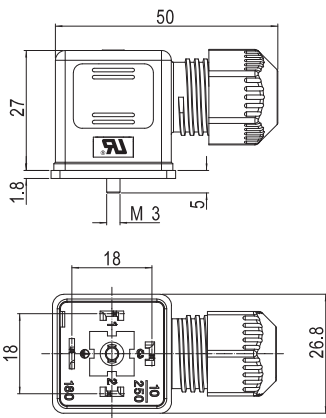

PIN assignment

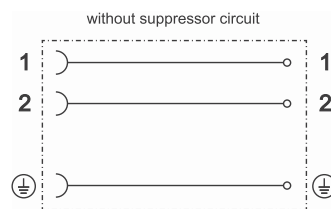

PIN assignment

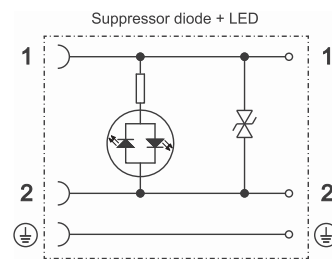

PIN assignment

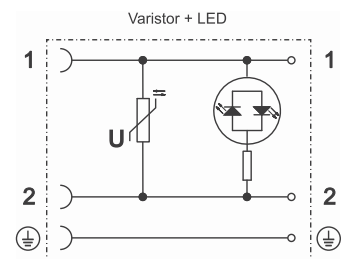

Suppression Technology - Valve Suppressors - special function

Adjustable male, form A (18 mm) 2pol. + 2×PE, IP65

Switching amplifier without galvanic insulation

Ground wire terminator, short-circuit-proof, 0°/180° mounting possible



Technical data

Type of function
Control current
Cut-off peak
Switching frequency
Switch-on delay
Switch-off delay
Short-circuit protection
Status indication
Degree of protection

Switching amplifier
10 mA
≤52 V
Max. 20 Hz
<100 μs
<200 μs
Short circuit protected
LED yellow
IP65

Mounting
Operation temperature range
Dimensions (w × h × d)
Connection type
Connection cross-section
Connection cross-section
Mechanical service life
Accessories

Breakaway torque 0.4 Nm
-25 °C ... +60 °C
28.0 mm × 40.0 mm × 58.0 mm
Screw terminal
0.5 – 1.5 mm²
AWG 20 – AWG 16
>100 insertion cycles
Marker holder BZT, white: Part-No.
681315 | BZT 0920 | PU: 100 units

Part No.	Type	Rated voltage U _N	Amperage range A	Connecting lead Ø	Color of the housing	Pole number	Design	PU (units)
Switching amplifier								
705509	S* LVER-V10-5509 DC 24V	DC 24 V	≤2	5 – 9 mm	black	3	A (18 mm)	10

Dimensions

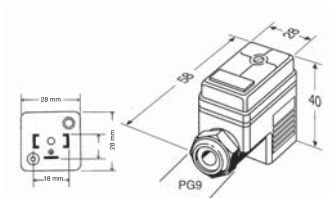

PIN assignment

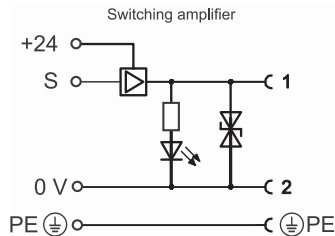

Suppression Technology - Valve Suppressors - special function

Adjustable male, form A (18 mm) 2pol. + 2xPE, IP65

- two cable entry points

Ground wire terminator (PE) adjustable in 180° steps, 0°/180° mounting possible



Technical data

Type of function
Rated frequency f_N
Degree of protection
Mounting
Operation temperature range
Dimensions (w × h × d)

Double valve suppressor
50 Hz / 60 Hz
IP65
Breakaway torque 0.4 Nm
-25 °C ... +60 °C
28.0 mm × 50.0 mm × 63.0 mm

Connection type
Connection cross-section
Connection cross-section
Mechanical service life
Accessories

Screw terminal
0.5 – 1.5 mm²
AWG 20 – AWG 16
>100 insertion cycles
Marker holder BZT, white: Part-No. 681315 | BZT 0920 | PU: 100 units

Part No.	Type	Rated voltage U_N	Amperage range A	Connecting lead Ø	Color of the housing	Pole number	Design	PU (units)
None protection device								
707514	S* LPG-V10-7514 up to 230 V	AC/DC 0–230 V	≤4	5 – 9 mm	black	3	A (18 mm)	10

Dimensions

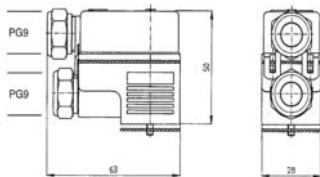

PIN assignment

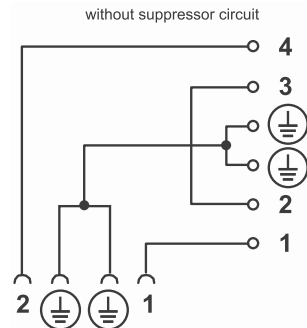

Suppression Technology - Valve suppressors

Adjustable male, form BI (11 mm)

Ground wire terminator (PE) adjustable in 180° steps

Protection device: without circuit / Z-Diode+LED / Varistor+LED



Technical data

Type of function
Status indication
Degree of protection
Mounting
Operation temperature range
Dimensions (w × h × d)

Valve suppressor
LED yellow
IP67
Breakaway torque 0.4 Nm
-40 °C ... +90 °C
21.0 mm × 30.3 mm × 51.0 mm

Connection type
Connection cross-section
Connection cross-section
Mechanical service life
Certifications

Screw terminal
max. 1.5 mm²
max. AWG 16
>100 insertion cycles
cURus (E256031)

Part No.	Type	Rated voltage U _N	Amperage range A	Connecting lead Ø	Color of the housing	Pole number	Design	PU (units)
None protection device								
705803	S*	L-V22-5803 AC/ DC 0-230V	AC/DC 0-230 V	≤10	4 – 9 mm	black	3	BI Ind. (11 mm) 1
Suppressor diode + LED								
705812	S*	LS-V22-5812 AC/DC 24V	AC/DC 24 V	≤4	4 – 9 mm	transparent	3	BI Ind. (11 mm) 1
Varistor + LED								
705832	S*	LV-V22-5832 AC/ DC 110-230V	AC/DC 110-230 V	≤1	4 – 9 mm	transparent	3	BI Ind. (11 mm) 1

Dimensions

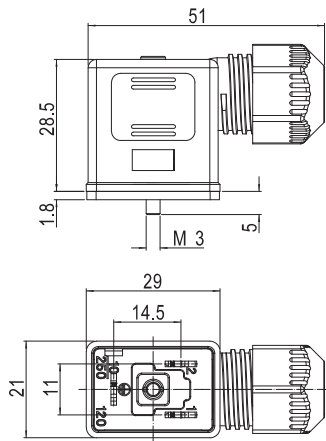

PIN assignment

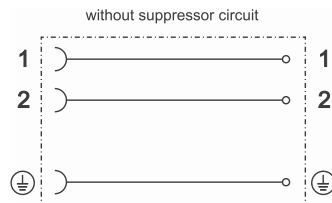

PIN assignment

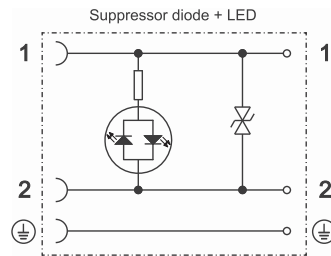

PIN assignment

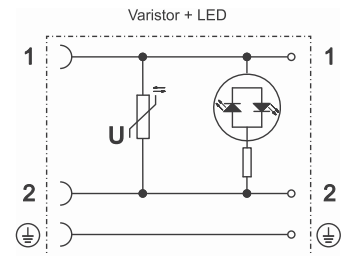

Suppression Technology - Valve Suppressors - special function

Adjustable connector, Construction B (10 mm), Construction BI (11 mm) 2pol. + PE, IP65
 Switching amplifier without galvanic insulation short circuit protection
 Ground wire terminator (PE) adjustable in 180° steps



Technical data

Type of function
 Control current
 Cut-off peak
 Switching frequency
 Switch-on delay
 Switch-off delay
 Short-circuit protection
 Status indication
 Degree of protection

Switching amplifier
 8 mA
 ≤ 52 V
 Max. 20 Hz
 $< 100 \mu\text{s}$
 $< 200 \mu\text{s}$
 Short circuit protected
 LED green
 IP65

Mounting
 Operation temperature range
 Dimensions (w x h x d)
 Connection type
 Connection cross-section
 Connection cross-section
 Mechanical service life
Accessories

Breakaway torque 0.4 Nm
 $-20 \text{ }^\circ\text{C} \dots +60 \text{ }^\circ\text{C}$
 22.0 mm x 40.0 mm x 58.0 mm
 Screw terminal
 0.5 – 1.5 mm²
 AWG 20 – AWG 16
 > 100 insertion cycles
Marker holder BZT, white: Part-No. 681315 | BZT 0920 | PU: 100 units

Part No.	Type	Rated voltage U_N	Amperage range A	Connecting lead \varnothing	Color of the housing	Pole number	Design	PU (units)
Switching amplifier								
705610	S* LVER-V11-5610 DC 24V	DC 24 V	≤ 2	5 – 9 mm	black	3	B DIN (10 mm)	10
705709	S* LVER-V12-5709 DC 24V	DC 24 V	≤ 2	5 – 9 mm	black	3	BI Ind. (11 mm)	10

Dimensions

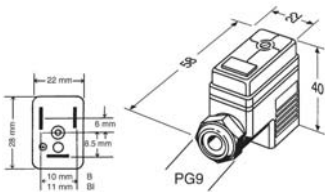

PIN assignment

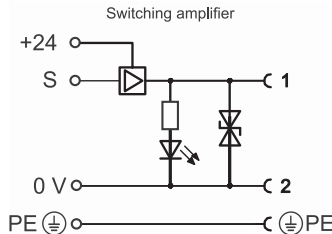

Suppression Technology - Valve Suppressors

Plug adapter for valve suppressors type A (18mm)

Protection device + LED

Mounting, plug seal not applicable



Technical data

Type of function
Rated voltage U_N
Color of the housing
Degree of protection
Mounting

Plug adapter
DC 24 V
black
IP65
plug-in
Plug seal not applicable

Operation temperature range
Dimensions (w × h × d)
Connection type
Pole number
Standards

-20 °C ... +60 °C
29,5 mm × 41,5 mm × 45,0 mm
Male contacts
2
EN 175301-803
ISO 4400

Part No.	Type	Rated voltage U_N	Cut-off peak V	Holding Capacity VA	Status indication	PU (units)
Diode + LED						
700861	S* LD-V8-0861 DC 24V	DC 24 V	≤1	100	LED green	10
Z-diode + LED						
700897	S* LZ-V8-0897 AC/DC 24V	AC/DC 24 V	≤52	15	LED green	10
Varistor + LED						
700881	S* LV-V8-0881N AC/DC 24V	AC/DC 24 V	≤100	200	LED green	10

Dimensions

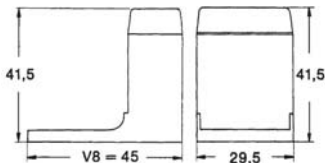

PIN assignment

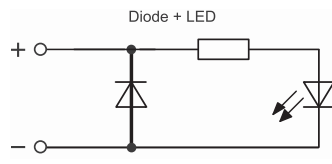

PIN assignment

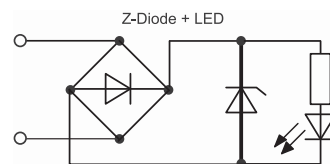

PIN assignment

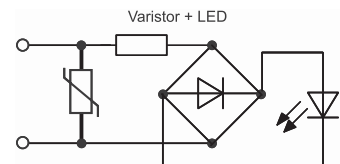

Suppression Technology - Valve Suppressors

Plug adapter for valve suppressors type A (18mm)

Protection device + LED

Mounting, plug seal not applicable



Technical data

Type of function
Rated voltage U_N
Color of the housing
Degree of protection
Mounting

Plug adapter
DC 24 V
black
IP65
plug-in
plug seal not applicable

Operation temperature range
Dimensions (w × h × d)
Connection type
Pole number
Standards

-20 °C ... +60 °C
29.5 mm × 41.5 mm × 45.0 mm
Male contacts
2
EN 175301-803
ISO 4400

Part No.	Type	Rated voltage U_N	Cut-off peak V	Holding Capacity VA	Status indication	PU (units)
Varistor + Capacitor + LED						
700867	S*	LCV-V8T-0867 DC 24V DC 24 V	≤100	50	LED green	10
RC module + glow lamp						
700910	S*	LRC-V8-0910 AC 115V AC 115 V	≤250	10	Glow lamp yellow	10
700857	S*	LRC-V8-0857 AC 230V AC 230 V	≤300	10	Glow lamp yellow	10

Dimensions

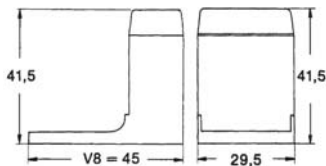

PIN assignment

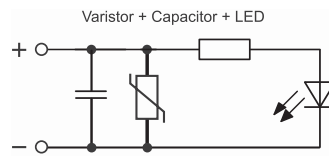

PIN assignment

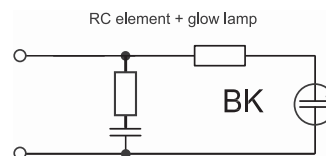

Suppression Technology - Valve Suppressors

Plug adaptor for valve suppressors type BI (11 mm)

Contact arrangement in 0° and 180° construction

Mounting, plug seal not applicable

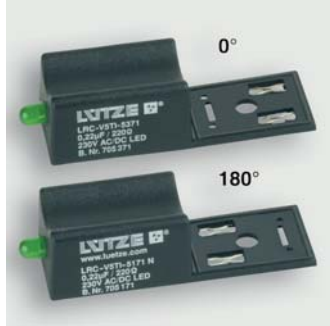

Technical data

Type of function
Rated voltage U_N
Color of the housing
Degree of protection
Mounting

Plug adaptor
AC/DC 24 V
black
IP65
plug-in

Operation temperature range
Dimensions (w × h × d)
Connection type
Pole number

Plug seal not applicable
-20 °C ... +60 °C
19.5 mm × 17.0 mm × 62.0 mm
Male contacts
2

Part No.	Type	Rated voltage U_N	Cut-off peak V	Holding Capacity VA	Status indication	PU (units)
Varistor + LED						
705341	S* LV-V5TI-5341 0° AC/DC 24V	AC/DC 24 V	≤100	200	LED green	10
705141	S* LV-V5TI-5141 180° AC/DC 24V	AC/DC 24 V	≤100	200	LED green	10

Dimensions

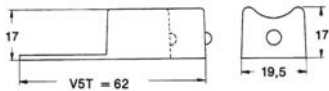

PIN assignment

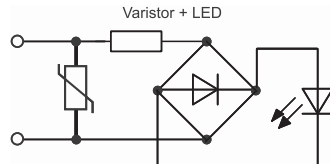

Suppression Technology - Motor suppression

Motor suppression for the direct installation in the motor junction plate

5.5 kW to 7.5 kW, 3 AC x 500 V

Protection device: Varistor

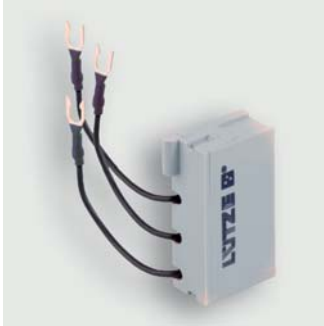

Technical data

Type of function
Cut-off peak
Type of connecting lead
Color of the housing
Degree of protection

Motor suppression
 ≤ 1075 V
1.5 mm² PVC
grey
IP67

Mounting
Operation temperature range
Dimensions (w x h x d)
Certifications

Motor terminal board inside
-20 °C ... +60 °C
40.0 mm x 21.0 mm x 13.0 mm

cURus (E135145)

Part No.	Type	Rated voltage U_N	Engine power kW	Rated frequency f_N	Cable length m	Connection type	PU (units)
Varistor							
706120	S* LV-S10-6120 3 AC 500V 5,5kW	3x AC 500 V	5.5	10 – 400 Hz	0.06	Fork-type cable lug M 5	10
706121	S* LV-S10-6121 3 AC 500V 7,5kW	3x AC 500 V	7.5	10 – 400 Hz	0.06	Fork-type cable lug M 5	10

Dimensions

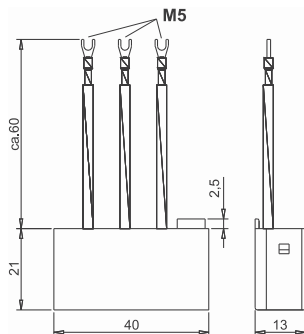

PIN assignment

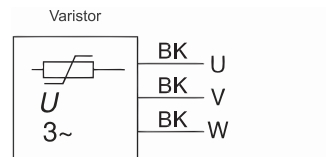

Suppression Technology - Motor suppression

Motor suppression for the screwing into the motor terminal box
 Also suitable for frequency converters up to 7.5 kW, 3 AC x 575 V
 Protection device: Varistor



Technical data

Type of function
 Cut-off peak
 Type of connecting lead
 Color of the housing
 Degree of protection

Motor suppression
 ≤ 1075 V
 1.5 mm² PVC
 grey
 IP67

Mounting

Operation temperature range
 Certifications

screwed
 into terminal housing
 -20 °C ... +60 °C

cURus (E135145)

Part No.	Type	Rated voltage U_N	Engine power kW	Rated frequen- cy f_N	Cable length m	Connection type	Fitting	PU (units)
Varistor								
701533	S* LV-RM1-1533 3AC 575V 4kW	3× AC 575 V	4	10 – 400 Hz	0.12	Ring termination M 5	M 16 × 1.5	10
701534	S* LV-RM2-1534 3AC 575V 7,5kW	3× AC 575 V	7.5	10 – 400 Hz	0.15	Ring termination M 6	M 32 × 1.5	10

Dimensions

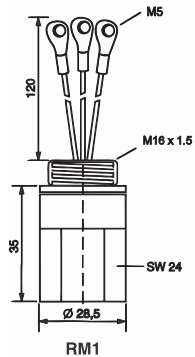

Dimensions

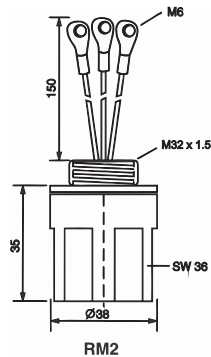

PIN assignment

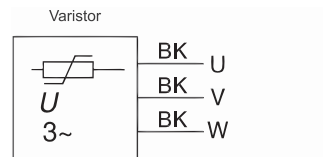

Suppression Technology - Motor suppression

Motor suppression for the direct installation in the motor junction plate
 7.5 kW, 3 AC x 500 V
 Protection device: RC module



Technical data

Type of function
 Type of connecting lead
 Color of the housing
 Degree of protection
 Mounting

Motor suppression
 1.0 mm² PVC
 grey
 IP67
 DIN rail mounting
 2 snap-on sockets

Operation temperature range
 Dimensions (w × h × d)
 Certifications

Motor terminal board inside
 -20 °C ... +60 °C
 15.0 mm × 40.0 mm × 48.0 mm

cURus (E135145)
Snap-on socket type 2, grey: Part-No.
 700499 | DIN rail mounting | PU: 10 units

Accessories

Part No.	Type	Rated voltage U _N	Engine power kW	Rated frequency f _N	Cable length m	Connection type	PU (units)
RC module							
706115	S* LRC-VM1-6115 3AC 500V 7,5kW	3× AC 500 V	7.5	50 Hz / 60 Hz	0.22	Fork-type cable lug M 4	20

Dimensions

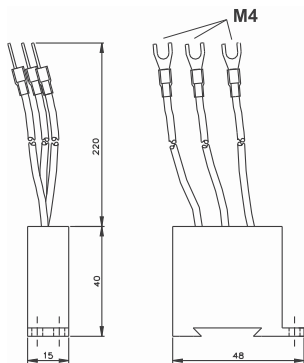

PIN assignment

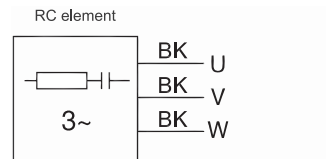

Suppression Technology - Motor suppression

Motor suppression for the screwing into the motor terminal box (PG9)

Up to 7.5 kW, 3 AC x 575 V

Protection device: RC module



Technical data

Type of function
Type of connecting lead
Connecting lead Ø
Color of the housing
Degree of protection
Mounting

Motor suppression
3×1.0 mm² PVC
6.3 mm
black
IP67
Motor terminal board outside

Operation temperature range
Dimensions (w × h × d)
Accessories

Cable tie on the supply cable
DIN rail mounting
2 snap-on sockets
-20 °C ... +60 °C
40.0 mm × 40.0 mm × 40.0 mm
Snap-on socket type 2, grey: Part-No. 700499 | DIN rail mounting | PU: 10 units

Part No.	Type	Rated voltage U _N	Engine power kW	Rated frequency f _N	Cable length m	Connection type	Fitting	PU (units)
RC module								
700374	S* LRC-M5-0374 3AC 500V 4kW	3× AC 500 V	4	50 Hz / 60 Hz	0.5	Line end open	PG 9	10
700379	S* LRC-M5-0379 3AC 575V 7,5kW	3× AC 575 V	7.5	50 Hz / 60 Hz	0.5	Line end open	PG 9	10

Dimensions

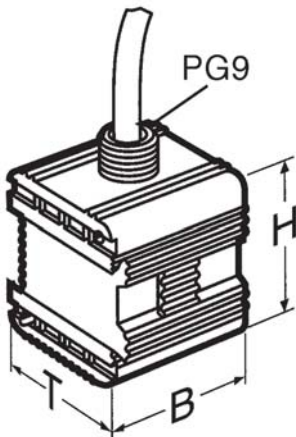

PIN assignment

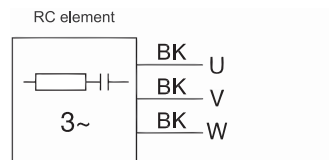

Suppression Technology - Motor suppression

Motor suppression for DIN rail mounting
 For AC motors up to 30 kW, 3 AC x 500 V
 Protection device: RC module



Technical data

Type of function
 Type of connecting lead
 Color of the housing
 Degree of protection
 Mounting

Motor suppression
 1.0 mm² PVC
 grey
 IP67
 DIN rail mounting
 2 snap-on sockets

Operation temperature range
 Certifications

Attachment hole m 4
 -20 °C ... +60 °C

Accessories

cURus (E135145)
Snap-on socket type 2, grey: Part-No. 700499 | DIN rail mounting | PU: 10 units

Part No.	Type	Rated voltage U _N	Engine power kW	Rated frequency f _N	Cable length m	Connection type	PU (units)
RC module							
700490	S* LRC-M1-0490 3AC 500V 4kW	3× AC 500 V	4	50 Hz / 60 Hz	0.22	Fork-type cable lug M 4	10
700491	S* LRC-M2-0491 3AC 500V 7,5kW	3× AC 500 V	7.5	50 Hz / 60 Hz	0.22	Fork-type cable lug M 4	10
700492	S* LRC-M2-0492 3AC 500V 15kW	3× AC 500 V	15	50 Hz / 60 Hz	0.22	Fork-type cable lug M 4	10
700493	S* LRC-M3-0493 3AC 500V 30kW	3× AC 500 V	30	50 Hz / 60 Hz	0.22	Fork-type cable lug M 4	10

Dimensions

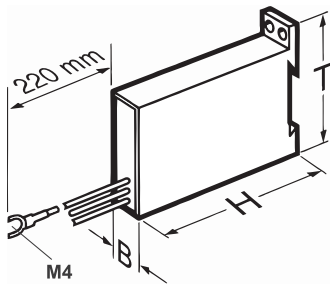

PIN assignment

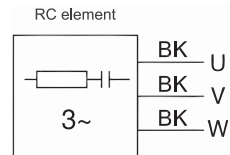

Suppression Technology - Motor suppression

Universal motor suppression: direct attachment to the switch, e.g. Siemens SIRIUS 3RT 10
 Also suitable for frequency converters up to 7.5 kW, 3 AC x 575 V

Protection device: Varistor

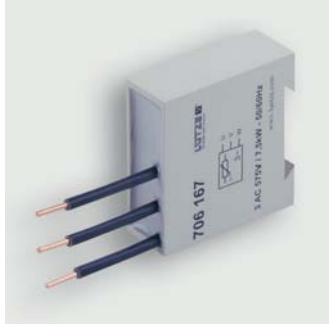

Technical data

Type of function
 Cut-off peak
 Type of connecting lead
 Color of the housing
 Degree of protection

Motor suppression
 ≤ 1075 V
 1.5 mm² PVC
 grey
 IP67

Mounting
 Operation temperature range
 Dimensions (w x h x d)
 Certifications

Attachment to contactor
 -20 °C ... +60 °C
 15.0 mm x 40.0 mm x 40.5 mm
 cURus (E135145)

Part No.	Type	Rated voltage U_N	Engine power kW	Rated frequency f_N	Cable length m	Connection type	PU (units)
Varistor							
706167	S* LV-VM1-6167 3AC 575V 7,5kW	3x AC 575 V	7.5	10 – 400 Hz	0.03	stripped cable ends	10

Dimensions

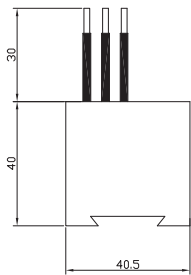

PIN assignment

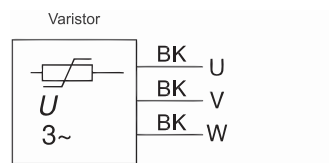

Suppression Technology - Motor suppression

As substructure for protection types up to 45 mm wide, for DIN rail mounting

For AC motors up to 2.5 kW, 3 AC x 400 V

Protection device: Varistor



Technical data

Type of function
Cut-off peak
Type of connecting lead
Color of the housing

Motor suppression
 ≤ 745 V
1.0 mm² PVC
grey

Degree of protection
Mounting
Operation temperature range
Dimensions (w × h × d)

IP20
DIN rail mountable TS35
-20 °C ... +60 °C
40.0 mm × 20.0 mm × 35.0 mm

Part No.	Type	Rated voltage U_N	Engine power kW	Rated frequency f_N	Cable length m	Connection type	PU (units)
Varistor							
700217	S* LV-S9-0217 3AC 400V 2,5KW	3× AC 400 V	2.5	10 – 400 Hz	0.15	Fork-type cable lug M 4	10

Dimensions

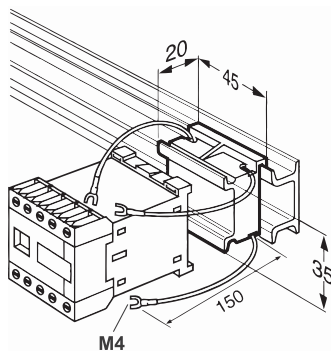

PIN assignment

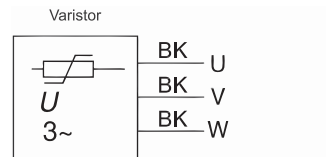

Technical information

BUS and Network	164
ETHERNET - Overview	165 - 167
Conductor structure	168
Color code tables	169
Conductor making	170
Properties of insulation materials	171
Current loads	172 - 173
Chemical resistance of PVC, TPE and PUR cable jackets	174
Design of the protection class designation according to EN 60529	175
Technical Terms	176
Certificates	177

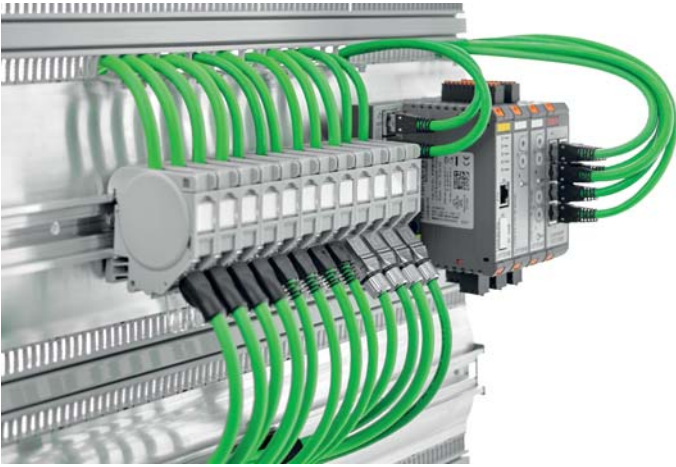

Bus- and Network cables

Bus-Systems have become a very vital part of factory automation and it's hard to imagine automation without it. Besides hardware and software components, passive components such as bus cables and connectors play an important role for reliable function of the system. Bus cables must comply with all electrical parameters of the particular system. There is no universally applicable bus cable as the individual requirements are to diverse. LÜTZE offers robust, industrial grade Bus- and Network cables for the most common used systems worldwide. These cables are being offered for fixed and flexible application as well as continuous moving application in drag chains.

Applications

ASI - Actuator-Sensor-Interface

The AS-Interface per EN 50295 is a serial Actuator Sensor Network being used for digital signals in the lower field levels. It works in accordance to the Master Slave Principle and presents a cost effective alternative to other serial bus systems.

Profibus

Profibus ist he most common Bus-System used in Europe in the area of automated manufacturing.

Profibus PA

The engineering of these cables per IEC 61158-2 fulfills the requirements in process automation and also offers intrinsically safe connection to the field devices. Profibus PA is a synchronous protocol with DC-current flow free transmission, which is also often designated as H1. The IEC 61158-2 Technique is applied at the PROFIBUS-PA.

Profibus DP

This Profibus variant, optimized through increased transmission speed and low installation cost, was especially designed for the communication between automation systems and decentralized peripheral devices in the field range. Profibus-DP substitutes the conventional parallel data communication with 24V or 0-20 mA. Lütze Profibus cables meet the specification for Profibus-DP type A according to EN 50254. Profibus-DP und Profibus FMS use the same transmission technology as well as a unified Bus protocol. Both variants can be operated simultaneously on one cable.

Profibus Fast Connect®

These cables have an optimized radial, symmetrical construction and can facilitate the application of special tools. Thereby, bus connector plugs are able to be assembled in a fast and installation-friendly way.

CAN-Bus

Can-Bus is specified according to ISO 11898. Primarily designed for automotive applications Can-Buses are used today for the exchange of digital information, Controller Area Network (CAN) for faster data transfer/data exchange.

Interbus

The Interbus-S was published in 1987 as an open sensor/ actuator bus protocol. As a typical sensor/actuator fieldbus, it is configured for the cyclic processing of process data and hence differentiates significantly from data orientated field buses. The main application area of Interbus-S lays in production engineering,, process engineering, as well as transport and logistics. Here the main focus is both the automotive industry and the drive technology.

DeviceNet

DeviceNet is a service related Network, based on the proven CAN-Technology for fast data exchange. The configuration consists of thick cable (aka Trunk cable) and thin cable (aka drop cable). The use of high flexing cables in drag chains is likewise possible. DeviceNet has been standardized by Open DeviceNet Vendor Association (ODVA) and is the leading bus system for industrial automation in North America.

Industrial Ethernet

Ethernet ist the most commonly used communication technology. The Ethernet Standard allows for a remarkable increase in the bandwidth, from 12 Mbits/s for a bus system, to up to 10 Gbit/s. In the office world the Ethernet Standard has already established itself as the standard technology, however the requirements for wiring systems and active components in the industrial environment differ greatly from those in an office environment. On one hand the infrastructure must be more robust; and on the other hand criteria such as real time application require special IT solutions. Consequently, this has resulted in the development of various proprietary systems such as ProfiNet, EtherCAT, Modbus TCP and Powerlink with system specific components which may not be compatible with others. A structured Ethernet cabling according to EN 50173-3 should support each proprietary system. While LÜTZE offers a large number of industrial Ethernet cable solutions we are pleased to have a special innovation with our drag chain suitable Cat6 Ethernet cable.

ETHERNET – Overview

1. Correct Handling and Installation of Network Copper Cable

- Do not subject cable to tension
- Do not kink the cable
- Do not bend the cable more than 90° (See individual specifications for bending radius)
- Strip the cable as short as possible
- Do not crush cable when fastening
- Do not untwist the conductor pairs by more than 15 mm
- Terminate the shielding on both ends

2. LÜTZE ETHERNET Cables

We recommend shielded industrial Ethernet cable, such as LÜTZE ETHERNET cable, for use in industrial environment to ensure secure connectivity. Motors and other electrical noise producing devices are often located in close proximity to network cabling. EMI (Electro Magnetic Interference) and RFI (Radio Frequency Interference) can distort data transmission on copper-based network cable. To lessen or eliminate interference, called alien-crosstalk, the use of shielded industrial cable and connectors is recommended.

Available LÜTZE ETHERNET Cables:

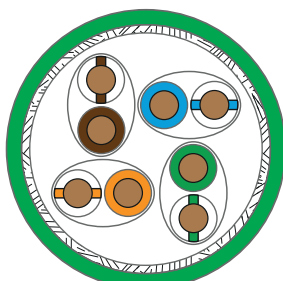

S/UTP

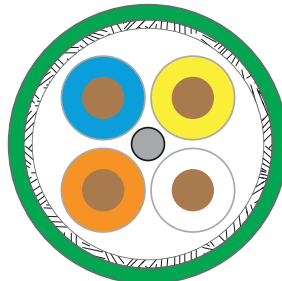

S/UTQ (Quad)

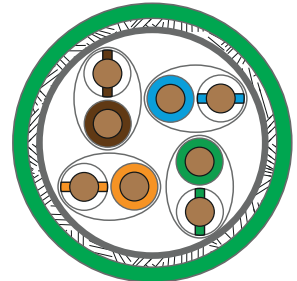

SF/UTP

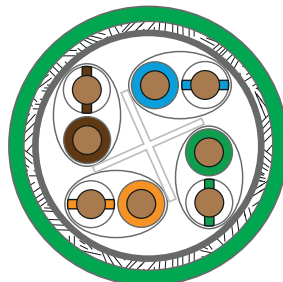

SF/UTP
with cross element

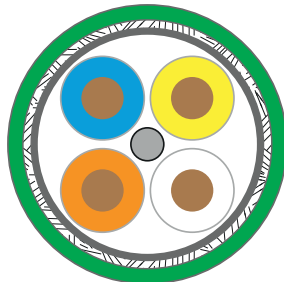

SF/UTQ (Quad)

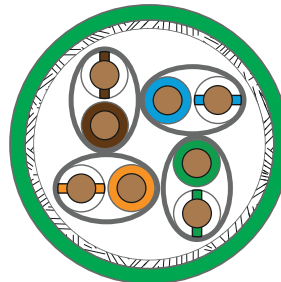

S/FTP

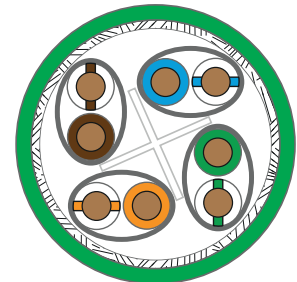

S/FTP
with cross element

Susceptibility for Interference

S/UTP	S/UTQ (Quad)	SF/UTP	SF/UTP with cross element	SF/UTQ (Quad)	S/FTP	S/FTP with cross element
some	some	low	low	low	low	low

3. Key for twisted pair cables according to ISO/IEC-11801 (2002)E

XX/YYZ

XX – outer jacket / Y – for the pair shielding / ZZ – wire pairing

U = unshielded / U = unshielded / TP = twisted pair (regular)
 F = foiled shield / F = foiled shield / TQ = quad pair (star quad)
 S = braided shield / S = braided shield
 SF = braided and foiled shield

In order to utilize EMI/RFI shielding, the shield must be properly terminated at both ends!

ETHERNET – Overview

ETHERNET cable selection tool

Category	Use	2- or 4- pair	Part number	Shielding	AWG	AD (mm)	UL Recognized	UL Listed Type
Cat. 5e	high flexing	2-pair	104050	SF/UTQ	22	6,5	cURus	
Cat. 5	high flexing	2-pair	104303	S/UTQ	22	6,5		CMX
Cat. 5e	high flexing	2-pair	104302	S/UTQ	22	6,6		CMX
Cat. 5e	high flexing	2-pair	104379	SF/UTQ	26	5,3	cURus	
Cat. 5e	high flexing	4-pair	104337	S/UTP	24	7,8	cURus	
Cat. 5e	high flexing	4-pair	104396	SF/UTP	26	6,7	cURus	
Cat. 5e	static	2-pair	104301	SF/UTQ	22-single wire	6,5	cURus	PLTC, CMG
Cat. 5e	static	2-pair	104307	SF/UTQ	22	6,5	cURus	PLTC, CMG
Cat. 5e	static	4-pair	104335	SF/UTP	26	6,3		CMG
Cat. 5e	static	4-pair	104336	SF/UTP	24	7,3		CMG
Cat. 5e	static	4-pair	104350	SF/UTP	22	8,6	cURus	PLTC, CMG, CMX Outdoor
Cat. 6	high flexing	4-pair	104347	SF/UTP	26	7,9		CMX
Cat. 6 _A	high flexing	4-pair	104401	SF/UTP	24	8,9	cURus	
Cat. 6 _A	static	4-pair	104397	S/FTP	22-single wire	9,6	cURus	PLTC, CMG
Cat. 6 _A	static	4-pair	104338	S/FTP	26	6,4		CMG
Cat. 7	high flexing	4-pair	104404	S/FTP	24	9,4		CMX
Cat. 7	static	4-pair	104331	S/FTP	26	6,4		CMG
Cat. 7	static	4-pair	104110	S/FTP	23	8,7	cURus	

ETHERNET – Overview

4. ProfiNet – Star Quad Design and Termination

The star quad is a specific low-impedance cable configuration. Four conductors are twisted on a common axis. The conductors across from each other make a pair.

In Image 1 the pairs are as follows:

Pair 1:
Conductor A ← → Conductor D

Pair 2:
Conductor B ← → Conductor C

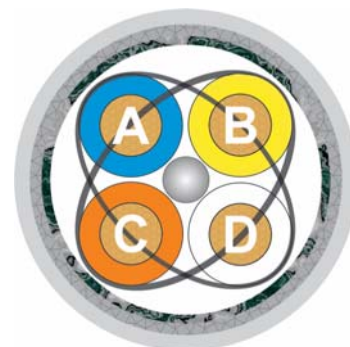

Image 1

Other terminations than in Figure 1 lead to interferences, decreased connectivity or no connectivity at all.

5. Pin Assignment and Installation

RJ45 is the most common Ethernet connector and is available both shielded and unshielded. All pins of the RJ45 connector are used for 1000 Mbit/s (4-pair transmission). Four pins are used for 10/100 Mbit/s (2-pair transmission).

According to the EN 50173 standard, two color codes are defined for installation: T568A and T568B. It makes no difference which color code is used, however the same code should be used consistently throughout the entire installation. Mixing up the two color codes will result in malfunctions.

Pin assignment RJ45 – Color code according to EN 50173 – hard wiring:

ETHERNET cables							
Pin#	Star Quad (ProfiNet)		Paired				
	100BASE-TX	Colorcode	10 BASE-T, 100BASE-TX	1000BASE-T		Colorcode T568A	Colorcode T568B
1	Transmit+	yellow	Transmit+	BI_DA+	(bidirectional)	WH/GN	WH/OR
2	Transmit-	orange	Transmit-	BI_DA-	(bidirectional)	GN	OR
3	Receive+	white	Receive+	BI_DB+	(bidirectional)	WH/OR	WH/GN
4	–		–	BI_DC+	(bidirectional)	BL	BL
5	–		–	BI_DC-	(bidirectional)	WH/BL	WH/BL
6	Receive-	blue	Receive-	BI_DB-	(bidirectional)	OR	GN
7	–		–	BI_DD+	(bidirectional)	WH/BN	WH/BN
8	–		–	BI_DD-	(bidirectional)	BN	BN

6. ETHERNET Categories and Classes

	ProfiNet®	Cat. 5	Cat. 5e	Cat. 6	Cat. 6A	Cat. 7
Class	D	D	De	E	Ea	F
Construction	2 pair (AWG 22)	2 pair (AWG22, AWG24, AWG26)	4 pair (AWG 24, AWG 26)	4 pair (26 AWG)	4 pair (AWG22, AWG24, AWG26)	4 pair (AWG22, AWG24, AWG26)
Speed	10/100 Mbit/s	10/100 Mbit/s	10/100/1000 Mbit/s	10/100/1000 Mbit/s	10/100/1000/10000 Mbit/s	10/100/1000/10000 Mbit/s
LAN Applications (max.)	10BASE-T (2 pair) 100BASE-TX (2 pair)	10BASE-T (2 pair) 100BASE-TX (2 pair)	10BASE-T (2 pair) 100BASE-TX (2 pair) 1000BASE-T (4 pair)	10BASE-T 100BASE-TX 1000BASE-T 10BASE-T	10BASE-T 100BASE-TX 1000BASE-T 10GBASE-T	10BASE-T 100BASE-TX 1000BASE-T 10GBASE-T
Nominal Impedance	100 Ohm	100 Ohm	100 Ohm	100 Ohm	100 Ohm	100 Ohm
Bandwidth	100 MHz	100 MHz	100 MHz	250 MHz	500 MHz	600 MHz
max. length	100 m (10BASE-T) 100 m (100BASE-TX)	100 m (10BASE-T) 100 m (100BASE-TX)	100 m (10BASE-T) 100 m (100BASE-TX) 100 m (1000BASE-T)	100 m (10BASE-T) 100 m (100BASE-TX) 100 m (1000BASE-T)	100 m (10BASE-T) 100 m (100BASE-TX) 100 m (1000BASE-T) 100 m (10GBASE-T)	100 m (10BASE-T) 100 m (100BASE-TX) 100 m (1000BASE-T) 100 m (10GBASE-T)
Cat. compatibility	Cat. 5	Cat. 5	Cat. 5	Cat. 5, Cat. 5e	Cat. 5, Cat. 6	Cat. 5, Cat. 6, Cat. 6A
ISO/IEC standard	–	ISO/IEC 11801	ISO/IEC 11801	ISO/IEC 11801	Modification 1 ISO/IEC 11801	ISO/IEC 11801
ANSI/TIA standard	–	ANSI/TIA-568-B	ANSI/TIA-568-C.2	ANSI/TIA-568-C.2	ANSI/TIA-568-C.2	Not recognized

Conductor structure according to DIN VDE 0295 / IEC 60228 and AWG

Conductor structure according to DIN VDE 0295 / IEC 60228

Cross section mm ²	Multi-stranded conductor	Many-stranded conductor	Finely stranded conductor	Superfine strand conductor			
	class 2 VDE 0295		class 5 VDE 0295	class 6 VDE 0295	Number of strands and individual strand mm		
0,14				18 x 0,10	18 x 0,10	36 x 0,07	72 x 0,05
0,25			14 x 0,15	32 x 0,10	32 x 0,10	65 x 0,07	128 x 0,05
0,34		7 x 0,25	19 x 0,15	42 x 0,10	42 x 0,10	88 x 0,07	174 x 0,05
0,38		7 x 0,27	12 x 0,20	21 x 0,15	48 x 0,10	100 x 0,07	194 x 0,05
0,50	7 x 0,30	7 x 0,30	16 x 0,20	28 x 0,15	64 x 0,10	131 x 0,07	256 x 0,05
0,75	7 x 0,37	7 x 0,37	24 x 0,20	42 x 0,15	96 x 0,10	195 x 0,07	384 x 0,05
1,00	7 x 0,43	7 x 0,43	32 x 0,20	56 x 0,15	128 x 0,10	260 x 0,07	512 x 0,05
1,50	7 x 0,52	7 x 0,52	30 x 0,25	84 x 0,15	192 x 0,10	392 x 0,07	768 x 0,05
2,50	7 x 0,67	19 x 0,41	50 x 0,25	140 x 0,15	320 x 0,10	651 x 0,07	1280 x 0,05
4	7 x 0,85	19 x 0,52	56 x 0,30	224 x 0,15	512 x 0,10	1040 x 0,07	
6	7 x 1,05	19 x 0,64	84 x 0,30	192 x 0,20	768 x 0,10	1560 x 0,07	
10	7 x 1,35	49 x 0,51	80 x 0,40	320 x 0,20	1280 x 0,10	2600 x 0,07	
16	7 x 1,70	49 x 0,65	128 x 0,40	512 x 0,20	2048 x 0,10		
25	7 x 2,13	84 x 0,62	200 x 0,40	800 x 0,20	3200 x 0,10		
35	7 x 2,52	133 x 0,58	280 x 0,40	1120 x 0,20			
50	19 x 1,83	133 x 0,69	400 x 0,40	705 x 0,30			
70	19 x 2,17	189 x 0,69	356 x 0,50	990 x 0,30			
95	19 x 2,52	259 x 0,69	485 x 0,50	1340 x 0,30			
120	37 x 2,03	336 x 0,67	614 x 0,50	1690 x 0,30			
150	37 x 2,27	392 x 0,69	765 x 0,50	2123 x 0,30			
185	37 x 2,52	494 x 0,69	944 x 0,50	1470 x 0,40			
240	61 x 2,24	627 x 0,70	1225 x 0,50	1905 x 0,40			
300	61 x 2,50	790 x 0,70	1530 x 0,50	2385 x 0,40			
400	61 x 2,89		2035 x 0,50				
500	61 x 3,23		1768 x 0,60				

The number of the strands is non-binding. The VDE 0295 determines only the maximum diameter of the single wire that is required for compliance with the maximum wire resistance at 20 °C.

Conductor structure according to AWG

Cross section mm ²	AWG	Copper wire	Braid copper not insulated — Wire structure					Standard values			
			flexible	very flexible		highly flexible		A max.	Cu weight		
		mm Ø	mm Ø	mm Ø	mm Ø	mm Ø	Ω/km	at 20 °C	kg/km		
0,08		0,32	10 x 0,10	0,37		40 x 0,05	0,37	210	0,5	0,71	
(0,09)	28	0,32	7 x 0,13	0,38		19 x 0,08	0,40	195		0,75	
0,10		0,36	14 x 0,10	0,44	28 x 0,07	0,44	51 x 0,05	0,42	190	1,0	0,98
0,14	26	0,39	18 x 0,10	0,49	36 x 0,07	0,49	72 x 0,05	0,50	138	1,5	1,27
(0,13)		0,40	7 x 0,16	0,49	10 x 0,13	0,53	19 x 0,10	0,51	130		1,30
(0,21)	24	0,51	7 x 0,20	0,61	19 x 0,13	0,61	41 x 0,08	0,58	85		2,00
0,25		0,57	14 x 0,15	0,66	32 x 0,10	0,66	128 x 0,05	0,75	77	2,5	2,27
(0,32)	22	0,64	7 x 0,25	0,76	19 x 0,16	0,80	26 x 0,13	0,76	56		3,00
0,34		0,64	7 x 0,25	0,75	42 x 0,10	0,74	180 x 0,05	0,80	56	4,5	3,10
0,50		0,80	16 x 0,20	0,95	28 x 0,15	0,95	256 x 0,05	1,00	39	6,0	4,50
(0,52)	20	0,81	7 x 0,32	0,90	19 x 0,20	0,94	41 x 0,13	0,91	33		5,00
0,75		0,98	24 x 0,20	1,20	42 x 0,15	1,20	385 x 0,05	1,20	26	10,0	6,90
(0,82)	18	1,02	7 x 0,40	1,22	19 x 0,25	1,27	65 x 0,13	1,20	21		8,00
1,00		1,15	32 x 0,20	1,30	57 x 0,15	1,30	511 x 0,05	1,40	20	15,0	9,20
(1,31)	16	1,30	7 x 0,51	1,52	19 x 0,30	1,47	105 x 0,13	1,50	16		11,00
1,50		1,40	30 x 0,25	1,60	85 x 0,15	1,85	196 x 0,10	1,85	14	20,0	14,10
(2,08)	14	1,62	7 x 0,64	1,85	19 x 0,36	1,85	105 x 0,16	1,85	11		19,00
2,50		1,80	51 x 0,25	2,10	142 x 0,15	2,25	322 x 0,10	2,40	8	25,0	23,20
(3,31)	12	2,05	7 x 0,80	2,50	19 x 0,46	2,35	165 x 0,16	2,41	6		28,00
(5,26)	10	2,60	37 x 0,40	2,80					3,8		42,00

Color code tables

Conductor color according to DIN VDE 0293-308

Cable and cables without green-yellow conductor

Number of conductor	Colors of the conductor				
2	blue	brown	-	-	-
3	-	brown	black	grey	-
4	blue	brown	black	grey	-
5	blue	brown	black	grey	black

Cable and cables without green-yellow conductor

Number of conductor	Colors of the conductor				
	Ground conductor	Active conductor			
3	green-yellow	blue	brown	-	-
4	green-yellow	-	brown	black	grey
5	green-yellow	blue	brown	black	grey

Not insulated concentric conductors, such as metallized jackets, armoring or shields are not considered as conductors in this table. A concentric conductor is identified by its arrangement and thus does not need to be identified by its color.

Conductor colors according to DIN 47100

Electronic data cables and computer cables with stranding with color repetition after 45 strands. The first color is the base colour of the strand. For multiple color strands, the identification marking consists of a base color and a ring color. The second or third color respectively is applied as ring identification marking. Ring width approx. 2 – 3 mm. A certain amount of blur of the identification colour at the edges and a small offset of both half rings is permitted. The manner of counting occurs from outside to inside through all layers consecutively.

No. Base/ring colors	No. Base/ring colors
1 white	32 yellow/blue
2 brown	33 green/red
3 green	34 yellow/red
4 yellow	35 green/black
5 grey	36 yellow/black
6 pink	37 grey/blue
7 blue	38 pink/blue
8 red	39 grey/red
9 black	40 pink/red
10 violet	41 grey/black
11 grey/pink	42 pink/black
12 red/blue	43 blue/black
13 white/green	44 red/black
14 brown/green	45 white
15 white/yellow	46 brown
16 yellow/brown	47 green
17 white/grey	48 yellow
18 grey/brown	49 grey
19 white/pink	50 pink
20 pink/brown	51 blue
21 white/blue	52 red
22 brown/blue	53 black
23 white/red	54 violet
24 brown/red	55 grey/pink
25 white/black	56 red/blue
26 brown/black	57 white/green
27 grey/green	58 brown/green
28 yellow/grey	59 white/yellow
29 pink/green	60 yellow/brown
30 yellow/pink	61 white/grey
31 green/blue	

Conductor color according to IEC for electronic cables with AWG design

Conductor no.	Color
1	black
2	brown
3	red
4	orange
5	yellow
6	green
7	blue
8	violet
9	grey
10	white
11	white-black
12	white-brown

The double color green-yellow may only be used for the grounding conductor (yellow is the base color). For the remaining double colors, the base color is white respectively.

For possibly required additional double colors, grey or brown are recommended as additional base colors.

Conductor marking acc. to DIN 47100 pairs and jacket colors acc. to RAL

Pair identification colour repetition after 45 pairs

Electronic data cables and computer cables with paired stranding. The first colour is the base colour of the strand. For multiple colour strands of the pair, the identification consists of a base colour and a ring colour. The second colour is applied as ring marking, ring width approx. 2 – 3 mm. A certain amount of blur of the identification colour at the edges and a small offset of both half rings are permitted from a manufacturing technique perspective.

The manner of counting occurs from outside to inside through all layers pairwise consecutively.

Paired stranding

Pair no.	a-strand	b-strand	Pair no.	a-strand	b-strand
1 23 45	white	brown	12 34 56	white/red	brown/red
2 24 46	green	yellow	13 35 57	white/black	brown/black
3 25 47	grey	pink	14 36 58	grey/green	yellow/grey
4 26 48	blue	red	15 37 59	pink/green	yellow/pink
5 27 49	black	violet	16 38 60	green/blue	yellow/blue
6 28 50	grey/pink	red/blue	17 39 61	green/red	yellow/red
7 29 51	white/green	brown/green	18 40	green/black	yellow/black
8 30 52	white/yellow	yellow/brown	19 41	grey/blue	pink/blue
9 31 53	white/gray	grey/brown	20 42	grey/red	pink/red
10 32 54	white/pink	pink/brown	21 43	grey/black	pink/black
11 33 55	white/blue	brown/blue	22 44	blue/black	red/black

Colour table according to RAL

Colour abbreviation according to HD 457

Colour	Short abbreviation	RAL	DESINA Outer jacket colour	DIN 47002 German	IEC 757 English
black	sw	9005	Power cable	sw	BK
brown	bn	8003		br	BN
red	rt	3000		rt	RD
orange	org	2003	Power cable	or	OG
yellow	ge	1021	Sensor-/actor cables	ge	YE
green	gn	6018	Signal cable	gn	GN
blue	bl	5015		bl	BU
violet	vio	4001	Bus/Fiber optic cable	vi	VT
silvergrey	gr	7001		gr	GY
pebble grey		7032			
window grey		7040	Control cable		
white	ws	9010		ws	WH
pink	rs	3015		pk	PK
turquoise (teal)	tk	5018		tq	TQ
green/yellow	gnge	6018/1021		gnye	GNYE
silver		-			SR
dark blue	dbl	5010		dbl	
dark brown	dbn	8014		dbn	
transparent	tr	-		tr	

Properties of insulation materials

Material	Abb.	Short abbreviation	Service temperature °C	Dielectric constant 10 ³	spec. contact Ohm x cm	Tensile strength N/mm ²	Elongation at break %	Absorption of water (20 °C) %	Weathering resistance	Fuel resistance	Oil resistance	Flammability
Polyvinyl chloride	PVC	Y	-30/+70	4 - 7	10 ¹² – 10 ¹⁵	10 – 25	150 – 300	0.4	moderate	moderate	good	self-extinguishing
Polyvinyl chloride heat resistant	PVC	Y	-20/+90	3.5	10 ¹² – 10 ¹⁵	10 – 25	150 – 300	0.4	moderate	moderate	good	self-extinguishing
High pressure polyethylene	LDPE	2Y	-50/+70	2.3	10 ¹⁷	20 – 30	500	0.1	good	low	moderate	flammable
Low pressure polyethylene	HDPE	2Y	-50/+100	2.3	10 ¹⁷	30	800	0.1	moderate	low	moderate	flammable
Polyurethane	PUR	11Y	-40/+90/100	4.0 – 6.0	10 ¹²	30 – 45	300 – 600	1.5	very good	good	good	self-extinguishing
Polyamide	PA	4Y	-40/+80	3.5 – 7.0	10 ¹⁴	50 – 180	200 – 300	1 – 2	good	moderate	good	flammable
Polybutylene terephthalate	PBTP	-	-60/+110	3.0 – 4.0	10 ¹⁶	50 – 100	50 – 300	0.5	good	good	good	flammable
Polytetrafluoroethylene	PTFE	5Y	-190/+260	2.1	10 ¹⁸	14 – 40	240 – 400	0.01	very good	very good	very good	not flammable
tetrafluoroethylene hexafluoro-propylene Copolymer	FEP	6Y	-100/+200	2.1	10 ¹⁸	20 – 25	250 – 350	0.01	very good	very good	very good	not flammable
Ethylene tetrafluoroethylene	ETFE	7Y	-100/+150	2.6	10 ¹⁶	40 – 50	100 – 300	0.01	very good	very good	very good	not flammable
Perfluoroalkoxy polymer	PFA	-	-190/+260	2.1	10 ¹⁵	30	300	0.01	very good	very good	good	not flammable
Chloroprene rubber	CR	5G	-40/+100	6.0 – 8.0	10 ¹³	25	450	1.0	very good	low	good	self-extinguishing
Silicon rubber	SI	2G	-60/+180	2.8 – 3.2	10 ¹⁵	5 – 10	200 – 350	1.0	very good	low	moderate	flame flammable
Ethylene vinyl acetate	EVA	4G	-30/+125	5 – 7	10 ¹³	5	200	0.01	good	low	low	flammable
Ethylene propylene rubber	EPM/ EPDM	3G	-30/+120	3.2	10 ¹⁴	5 – 25	200 – 450	0.02	good	low	low	flammable
Thermoplastic polyolefin Elastomer	TPE-O	18Y	-40/+120	2.7 – 3.6	5 x 10 ¹⁴	>6	>400	1.5	very good	moderate	moderate	flammable
Thermoplastic polyester Elastomer	TPE-E	12Y	-70/+125	3.7 – 5.1	10 ¹²	3 – 25	280 – 650	0.3 – 0.6	very good	good	very good	flammable
Styrol triblock Copolymer	TPE-S	-	-75/+105/140	2.2 – 2.6	10 ¹⁶	9 – 25	500 – 700	1 – 2	moderate	good	low	flammable

Only for basic materials, deviations are possible depending on the indented use/design.

Current loads

Current rating of cables with rated voltage up to 1000 V and of heat-resistant cables.
(cf. VDE 0298-4, 2003-08, Table 11)

	Group 1 Single-wire cables	Group 2 Multi-wire cables for household appliances and hand tools	Group 3 Multi-wire cables not for household appliances and hand tools	
	<ul style="list-style-type: none"> • Insulated with rubber • Insulated with PVC • Insulated with TPE • Heat resistant 	<ul style="list-style-type: none"> • Insulated with rubber • Insulated with PVC • Insulated with TPE 	<ul style="list-style-type: none"> • Insulated with rubber • Insulated with PVC • Insulated with TPE 	
Installation type	Free in air	On or at the surface		
Number of current carrying conductors	1	2	3	2 oder 3
Nominal cross section in mm ²	Current rating in Ampere			
0,14 *	3	-	-	2
0,25 *	5	-	-	4
0,34 *	8	-	-	6
0,5 *	12	3	3	9
0,75	15	6	6	12
1,0	19	10	10	15
1,5	24	16	16	18
2,5	32	25	20	26
4	42	32	25	34
6	54	40	-	44
10	73	63	-	61
16	98	-	-	82
25	129	-	-	108
35	158	-	-	135
50	198	-	-	168
70	245	-	-	207
95	292	-	-	250
120	344	-	-	292
150	391	-	-	335
185	448	-	-	382
240	528	-	-	453
Based on DIN VDE 0298-4 2003-08	Table 11 column 1 e.g. H07V-K, LÜTZE SUPERFLEX® PLUS PUR single-conductor	Table 11 column 3 and 4		Table 11 column 5 z.B. LÜTZE SILFLEX® and LÜTZE SUPERFLEX® cables
Conversion factor for				
Deviating ambient temperature	Temperature	-	-	Temperature
Multi-conductor cables	-	-	-	Number of conductors

* not official part of VDE 0298-4 2003-08. Current rating in accordance with 0891-1 or 0298-4 2003-08.

Note 1:

This table deviates from the table in VDE 0298-4. If there is uncertainty, the latest version of DIN VDE 0298-4 is valid. The actual current rating is also influenced by deviating ambient temperature, as well as the number of conductors in a cable. In this case the derating factors from table "Temperature" and "Number of conductors" must be used.

Note 2:

The descriptions shown here are reference values and in simplified form taken from VDE 0298-4 2003-8. If necessary additional conversion factors for accumulation, installation in tubes or cable racks must be taken from the entire version of VDE 0298-4 2003-8. Should there be newer versions available after printing deadline, these must be considered. LÜTZE assumes no guarantee for the completeness or the correctness of any information provided here.

Current loads

Temperature

Conversion factors for deviating ambient temperature
(see VDE 0298-4 2003-08 Table 17, column 4, 5 and 7)

Ambient temperature	Factor 70 °C at the conductor	Factor 80 °C at the conductor	Factor 90 °C at the conductor
10 °C	1,22	1,18	1,15
15 °C	1,17	1,14	1,12
20 °C	1,12	1,10	1,08
25 °C	1,06	1,05	1,04
30 °C	1,00	1,00	1,00
35 °C	0,94	0,95	0,96
40 °C	0,87	0,89	0,91
45 °C	0,79	0,84	0,87
50 °C	0,71	0,77	0,82
55 °C	0,61	0,71	0,76
60 °C	0,50	0,63	0,71
65 °C	0,35	0,55	0,65
70 °C	-	0,45	0,58
75 °C	-	0,32	0,50
80 °C	-	-	0,41
85 °C	-	-	0,29

Number of conductors

Conversion factors for multi-conductor cable with a nominal cross section up to 10 mm² (see VDE 0298-4 2003-08 Table 26, column 2)

Number of loaded conductors	Factor
5	0,75
7	0,65
10	0,55
14	0,50
19	0,45
24	0,40
40	0,35
61	0,30

Note:

If necessary additional conversion factors for accumulation, installation in tubes or cable racks must be taken from the entire version of VDE 0298-4 2003-8. LÜTZE assume no guarantee for the completeness or the correctness of any information provided here.

Chemical resistance of PVC, TPE and PUR cables jackets

Anorganic	Concentration	PVC	TPE	PUR
Alaune	c.s.	+	+	
Aluminium salts	ec.	+	+	+
Ammonia, a	10 %	+	+	+
Ammonium acetate, a	ec.	+	+	
Ammonium carbonate, a	ec.	+	+	-
Ammonium chloride, a	ec.	+	+	+
Barium salts	ec.	+	+	+
Boric acid	100 %	+	+	O
Calcium chlorid, a	c.s.	+	+	O
Calcium chlorid, a	10 % and 40 %			+
Calcium nitrate, a	c.s.	+	+	
Chrom salts, a	c.s.	+	+	+
Calium carbonate, a (potash)		+	+	
Potassium chlorate, a	c.s.	+	+	
Potassium chloride, a	c.s.	+	+	O
Calcium dichromate, a		+	+	
Calcium iodide, a		+	+	
Calcium nitrate, a	c.s.	+	+	+
Potassium permanganate , a		O	O	-
Potassium sulfate, a		+	+	+
Copper salts, a	c.s.	+	+	+
Magnesium salts, a	c.s.	+	+	O
Sodium carbonate, a (Natron)		+	+	O
Sodium bisulfate, a		+	+	
Sodium chloride , a (common salt)		+	+	+
Sodium thiosulfate, a (fixing salt)		+	+	O
Nickel salts, a	c.s.	+	+	+
Phosphoric acid	50 %	+	+	-
Mercury	100 %	+	+	+
Mercury salts, a	c.s.	+	+	+
Nitric acid	30 %	-	-	-
Hydrochloric acid	concentration	-	-	-
Sulfur	100 %	+	+	+
Sulfur dioxide,	gaseous	+	+	O
Carbon disulfide		-	-	-
Hydrogen sulfide		+	+	-
Sea water		+	+	+
Silver salts, a		+	+	+
Hydrogen peroxide, a	3 %	+	+	+
Zinc salts, a		+	+	-
Tin(II) chloride		+	+	-
Organic	Concentration	PVC	TPE	PUR
Ethyl alcohol	100 %	-	-	-
Formic acid	30 %	-	-	-
Benzine/Benzene		-	O	+
Succinic acid, a	c.s.	+	+	-
Acetic acid	20 %	O	O	O
Hydraulic oil		-	*	O*
Isopropyl alcohol	100 %	-	-	O
Kerosene			O	O
Machine oil		O*	O*	+
Methyl alcohol, a	100 %	O	O	O
Mineral oil, depending on type (ASTM)			*	*
Oxalic acid, a	c.s.	+	+	
Paraffin oil			+	+
Plant oils and greases		O/+*	+	O/+*
Cutting oil		O*	O/+*	+
Tartaric acids, a		+	+	
Citric acid		+	+	

Legend: ec. = each concentration a = aqueous
c.s. = cold saturated + = resistant
O = conditionally resistant - = unstable
* = depending on the additives in oil

Disclaimer: This information shall only serve as support for choosing a suitable material for use with chemical substances. Prior to the final installation a test of the material should be performed with the chemical substances under prospective conditions of use. Lütze assumes no guarantee for the completeness or the correctness of this content, and declines all liability claims, which relate to loss or damage, which was caused by the use of the presented information or recommendations.

All specification refer to room temperature!

Design of the protection class designation according to EN 60529

The protection of electrical equipment through corresponding enclosure is specified with code letters and code numbers. This protection class designation consists of the letters "IP" and two code numbers from 0 to 8. The first code number stands for the protection against contact and foreign substances, the second number specifies the degree of protection against water. The higher the respective code number is, the higher is the offered protection. The valid protection class for each product is specified in the technical data.

For example the designation:

IP 65	Code letter IP	IP	
	First code number	6	corresponds to: Protection against entrance of dust
	Second code number	5	corresponds to: Protection against sprayed water

For protection against contact and foreign substances

First code number	Protection scope designation	Explanation
0	No protection	No special protection of persons from accidental contact with standing or moving parts under voltage. No protection of the equipment against entry of solid foreign substances.
1	Protection against foreign substances > 50 mm	Protection against accidental contact of large area surfaces of standing and internally moving parts under voltage, e.g. with the hand, but no protection against intentional access to these parts. Protection against entry of solid foreign substances with a diameter larger than 50 mm.
2	Protection against foreign substances > 12 mm	Protection against contact by the fingers of standing or internally moving parts under voltage. Protection against entry of solid foreign substances with a diameter larger than 12 mm.
3	Protection against foreign substances > 2.5 mm	Protection against contact of standing or internally moving parts under voltage with tools, wires or similar of a thickness larger than 2.5 mm. Protection against entry of solid foreign substances with a diameter larger than 2.5 mm.
4	Protection against foreign substances > 1 mm	Protection against contact of standing or internally moving parts under voltage with tools, wires or similar of a thickness larger than 1 mm. Protection against entry of solid foreign substances with a diameter larger than 1 mm.
5	Protection against dust accumulation	Full protection against contact of standing or internally moving parts under voltage moving parts under voltage. Protection against dust accumulation. The entry of dust is not fully prevented but the dust may not enter in such quantities that the functioning is impaired.
6	Protection against dust accumulation	Full protection against contact of standing or internally moving parts under voltage moving parts under voltage. Protection against entry of dust.

For water protection

Second code number	Protection scope designation	Explanation
0	No protection	No special protection
1	Protection from vertically falling dripping water	Water drops that fall vertically may not have any damaging effect.
2	Protection from dripping water falling at an angle	Water drops that fall at an arbitrary angle of up to 15° to vertical may not have any damaging effect.
3	Protection from sprayed water	Water that falls in an arbitrary angle up to 60° to vertical may not have a damaging effect.
4	Protection from splashed water	Water that is splashed from all directions against the equipment may not have a damaging effect.
5	Protection from water projected from a nozzle	Water projected from a nozzle that is aimed at the equipment from all directions may not have any damaging effect.
6	Protection against flooding	Water may not enter into the equipment in damaging amounts during temporary flooding (e.g. by heavy seas)
7	Protection against immersion	Water may not enter in damaging amounts if the equipment is immersed in water for the defined pressure and time conditions.
8	Protection against submersion	Water may not enter in damaging amounts if the equipment is submerged in water for the defined pressure and indefinite amount of time.

You can find the valid protection class for the respective product in the technical data.

Technical Terms

A	Ampere – unit of electric current
NEC	National Electric Code (USA)
NEMA	National Electrical Manufactureres Association (USA)
Rated voltage	Electric voltage in stranded operation
NFPA	National Fire and Protection Agency (USA)
Optical coverage	Degree of coverage by the copper braid shield (how dense the shield is braided)
Ozone resistance	Ability of the material to withstand ozone radiation
Paired	There are 2 conductors twisted with each other in the cable
PE	Protective Earth – Protection conductor
PiMF	Pairs in Metal Foil – twisted pair cabled pairs of conductors are shielded separately
Polyethylen (PE)	Insulation material with very good electric characteristics, low water-absorption, high viscosity and excellent dielectric values
Polyolefin	Insulation material with good electric characteristics, good chemical resistance as well as high viscosity and ultimate elongation. Belongs to the Group of semi-crystalline thermoplastics
Polypropylen (PP)	Insulation material with good electric characteristics as well as high strength and stability. Belongs to the group of semi-crystalline thermoplastics
Polyurethan (PUR)	Thermoplastic Polyurethane – High-quality jacket-material for the usage in cable tracks and harsh environmental conditions
Polyvinylchlorid (PVC)	Popular jacket material for industrial control cable, allowed due to compounds with additives high flexibility and improved oil resistance
Test voltage	Represents the voltage with which the cable has been tested
RAL-Number	Numbered color system for definite identification of a color type
RoHS	Restriction of Hazardous Substances
Layer pitch optimized	The lay length of the cabled conductors will be optimized for the application shorter lay lengths for higher alternating bending
Loop resistance	In the transmission technique the loop resistance is the resistance of a at the end short-circuit pair of conductors am (Forward- and return cable e.g. of a BUS- cable)
Protective conductor	Grounding conductor
Self-extinguishing	The characteristic of a material to extinguish flames by itself (eg. PVC)
Servo	The name of a supply- and motor connection cable
Zero potential	High quality stranding technique for cabled conductor without mechanical back twist. Especially important for high-flexible cables for the use in cable tracks
StC	Double shielded (Static shiel/foil+braid)
Star quad	Four conductors are cabled around a common axis
Control pair	Twisted conductor pairs for signal transmission in motor cables
Interfering signal	Cable- or fieldbound interferences
Radiation resistance	Resistance agaist radiation
Talcum	Talcum is used in powder as a release agent between the jacket and the conductor cable core. This allows the jacket to be removed easier later on
Temperature range	The recommended temperature range for the use of a cable
Thermoplastics	Thermoplastics can be transferred in a plastic state by heat supply
TI	Classification of characteristics of PVC Insulation material according to EN 50363
TM	Classification of characteristics of PVC jacket material according to EN 50363
Torsion	Here: The rotation of a cable around the logitudinal axis Specification for cable in °/m
TP	Twisted pair
TPE	Thermoplastic elastomere – High-quality material with good mechanical stress characteristics. Divided into various subgroups
U0/U	Rated volatge/Operating voltage
UL	Underwriters Laboratories
V	Volt
VDE	Association of Electrical, Electronic and Information Technologies
Rotproof	Increased resistance to rotting
Fleece wrap	A fleece wrapped around the conductors to protect the conductors and for better gliding characteristics.
VW-1	Flam test of UL (Vertical Wire Flame Test)
Wall thickness	The thickness of the jacket
Bend strength	The ability of a material not to break during permanent bending
Tear-resistant	The ability of a material to resists further cracking after a tear occurred
Characteristic impedance	Complex input resistance of infinite cable.
x	Ground conductor is not existing (like OZ, OB)
XLPE	Cross-linked polyethylene = XLPE
Tensile strenght	The maximum tension (pulling)
Tension	Tension which is built up in the direction of the external load in the interior of an object
Sub jacket	Between conductor and shield introduced separation layer to protect the wires
Ω	Ohm

Certificates



CERTIFICATE



This is to certify that

Friedrich Lütze GmbH
 Bruckwiesenstraße 17-19
 71384 Weinstadt
 Germany

with the organizational units/sites as listed in the annex

has implemented and maintains an **Environmental Management System**.

Scope:
 Development, production and distribution of electrical and electronic components and solutions for the automation technology

Through an audit, documented in a report, it was verified that the management system fulfills the requirements of the following standard:

ISO 14001 : 2015

Certificate registration no.	001737 UM15
Valid from	2021-04-18
Valid until	2024-04-17
Date of certification	2021-04-10



DQS GmbH

Markus Bleher

Markus Bleher
Managing Director



Accredited Body: DQS GmbH, August-Schanz-Straße 21, 60433 Frankfurt am Main, Germany



CERTIFICATE



This is to certify that

Friedrich Lütze GmbH
 Bruckwiesenstraße 17-19
 71384 Weinstadt
 Germany

with the organizational units/sites as listed in the annex

has implemented and maintains a **Quality Management System**.

Scope:
 Development, production and distribution of electrical and electronic components and solutions for the automation technology

Through an audit, documented in a report, it was verified that the management system fulfills the requirements of the following standard:

ISO 9001 : 2015

Certificate registration no.	001737 QM15
Revision date	2021-04-30
Valid from	2021-06-14
Valid until	2024-06-13
Date of certification	2021-04-29



DQS GmbH

Markus Bleher

Markus Bleher
Managing Director



Accredited Body: DQS GmbH, August-Schanz-Straße 21, 60433 Frankfurt am Main, Germany

Part number index

Part-No	Page	Part-No	Page	Part-No	Page	Part-No	Page	Part-No	Page	Part-No	Page
170430.1000	26	192766.2000	69	193273.1000	29	198060.1000	45	198287.1000	37	198439.1000	43
171395.1000	26	193001.1000	31	193276.1000	29	198062.1000	38	198288.1000	37	198440.1000	45
171523.1000	26	193004.1000	30	193278.1000	29	198063.1000	35	198289.1000	37	198441.1000	33
171743.1000	26	193028.1000	28	193279.1000	29	198064.1000	38	198292.1000	35	198442.1000	43
171744.1000	26	193029.1000	28	193282.1000	30	198066.1000	35	198293.1000	35	198443.1000	33
190003	20	193030.1000	28	193301.1000	24	198067.1000	38	198294.1000	35	198444.1000	43
190004	20	193031.1000	28	193303.1000	24	198068.1000	35	198295.1000	53	198445.1000	33
190005	20	193032.1000	28	193306.1000	21	198071.1000	35	198296.1000	37	198446.1000	43
190006	20	193033.1000	28	193307.1000	24	198073.1000	35	198297.1000	37	198447.1000	33
190007	20	193034.1000	31	193308.1000	24	198075.1000	47	198298.1000	37	198448.1000	43
190008	20	193035.1000	28	193309.1000	24	198076.1000	37	198299.1000	35	198449.1000	33
190009	20	193036.1000	28	193311.1000	24	198078.1000	35	198300.1000	44	198450.1000	45
190010	20	193037.1000	28	193337.1000	22	198080.1000	47	198302.1000	44	198451.1000	43
190012	20	193038.1000	28	193350.1000	25	198081.1000	37	198303.1000	44	198452.1000	33
190013	20	193039.1000	28	193352.1000	21	198083.1000	35	198304.1000	44	198453.1000	43
190014	20	193054.1000	28	193353.1000	21	198085.1000	47	198305.1000	44	198454.1000	33
190015	20	193055.1000	28	193355.1000	24	198086.1000	37	198306.1000	44	198455.1000	43
190016	20	193060.1000	28	193356.1000	21	198088.1000	35	198309.1000	35	198456.1000	33
190017	20	193061.1000	28	193357.1000	21	198090.1000	47	198310.1000	46	198457.1000	43
190018	20	193062.1000	28	193358.1000	22	198091.1000	37	198311.1000	46	198458.1000	33
190019	20	193077.1000	28	193360.1000	24	198093.1000	35	198312.1000	46	198459.1000	43
190560	20	193078.1000	28	193361.1000	24	198095.1000	47	198313.1000	46	198460.1000	47
192000.0100	62	193079.1000	28	193362.1000	21	198096.1000	37	198314.1000	46	198461.1000	37
192010.0100	62	193088.1000	31	193364.1000	23	198098.1000	34	198315.1000	46	198463.1000	33
192013.0030	66	193089.1000	29	193366.1000	23	198100.1000	47	198316.1000	46	198464.1000	43
192013.0060	66	193090.1000	29	193369.1000	21	198101.1000	37	198317.1000	44	198465.1000	33
192013.0100	66	193091.1000	29	193370.1000	23	198103.1000	34	198318.1000	44	198466.1000	43
192013.0150	66	193092.1000	29	193371.1000	23	198104.1000	34	198319.1000	44	198467.1000	33
192013.0200	66	193093.1000	29	193373.1000	23	198105.1000	53	198320.1000	36	198468.1000	43
192013.0500	66	193094.1000	30	193374.1000	23	198106.1000	34	198321.1000	34	198469.1000	33
192013.1000	66	193095.1000	29	193375.1000	23	198107.1000	34	198322.1000	34	198473.1000	43
192013.1500	66	193097.1000	29	193376.1000	23	198108.1000	34	198323.1000	34	198475.1000	40
192013.2000	66	193098.1000	29	193379.1000	23	198109.1000	34	198325.1000	36	198476.1000	50
192014.0030	59	193099.1000	30	193616.1000	29	198110.1000	53	198326.1000	44	198477.1000	40
192014.0060	59	193100.1000	29	193952.1000	23	198115.1000	47	198327.1000	44	198478.1000	50
192014.0100	59	193101.1000	29	193955.1000	23	198116.1000	37	198328.1000	44	198479.1000	40
192014.0150	59	193102.1000	30	193956.1000	21	198120.1000	53	198329.1000	44	198480.1000	47
192014.0200	59	193103.1000	30	193957.1000	24	198123.1000	34	198330.1000	44	198481.1000	37
192014.0500	59	193104.1000	30	193958.1000	25	198124.1000	34	198331.1000	44	198483.1000	50
192014.1000	59	193105.1000	29	193959.1000	22	198126.1000	34	198332.1000	44	198484.1000	40
192014.1500	59	193106.1000	29	193960.1000	21	198128.1000	34	198333.1000	46	198485.1000	50
192014.2000	59	193107.1000	29	193961.1000	21	198129.1000	34	198334.1000	46	198486.1000	40
192015.0030	67	193108.1000	29	193962.1000	21	198130.1000	53	198335.1000	46	198487.1000	50
192015.0060	67	193109.1000	29	193963.1000	23	198132.1000	34	198336.1000	46	198488.1000	40
192015.0100	67	193110.1000	29	193966.1000	21	198133.1000	34	198337.1000	46	198489.1000	50
192015.0150	67	193111.1000	30	193967.1000	23	198136.1000	34	198338.1000	46	198493.1000	41
192015.0200	67	193112.1000	30	193968.1000	23	198139.1000	34	198339.1000	46	198494.1000	51
192015.0500	67	193113.1000	30	193973.1000	25	198140.1000	53	198340.1000	36	198495.1000	41
192015.1000	67	193114.1000	30	193977.1000	25	198146.1000	37	198341.1000	36	198496.1000	51
192015.1500	67	193115.1000	30	193978.1000	25	198150.1000	53	198342.1000	36	198499.1000	40
192015.2000	67	193116.1000	30	193979.1000	25	198160.1000	53	198343.1000	36	198500.1000	47
192016.0030	60	193117.1000	30	193983.1000	24	198170.1000	53	198344.1000	36	198501.1000	37
192016.0060	60	193118.1000	30	193985.1000	24	198176.1000	36	198345.1000	36	198503.1000	50
192016.0100	60	193119.1000	29	193989.1000	24	198177.1000	36	198346.1000	36	198504.1000	40
192016.0150	60	193120.1000	29	193990.1000	21	198178.1000	36	198349.1000	47	198505.1000	50
192016.0200	60	193121.1000	30	193991.1000	24	198179.1000	36	198353.1000	35	198506.1000	41
192016.0500	60	193122.1000	30	193994.1000	24	198182.1000	36	198360.1000	45	198507.1000	51
192016.1000	60	193123.1000	30	193996.1000	24	198184.1000	39	198380.1000	45	198530.1000	47
192016.1500	60	193124.1000	30	196495.1000	26	198186.1000	39	198398.1000	43	198531.1000	37
192016.2000	60	193125.1000	29	196938.1000	26	198187.1000	49	198399.1000	43	198535.1000	32
192017.0030	68	193126.1000	31	196955.1000	26	198191.1000	53	198400.1000	45	198536.1000	32
192017.0060	68	193131.1000	27	197457	54	198198.1000	45	198401.1000	43	198553.1000	32
192017.0100	68	193132.1000	27	197458	54	198200.1000	53	198403.1000	43	198554.1000	32
192017.0150	68	193133.1000	27	197500	54	198204.1000	48	198406.1000	33	198560.1000	47
192017.0200	68	193134.1000	27	197501	54	198205.1000	34	198407.1000	33	198561.1000	37
192017.0500	68	193135.1000	27	197502	54	198210.1000	53	198408.1000	33	198570.1000	47
192017.1000	68	193146.1000	31	197503	54	198214.1000	44	198409.1000	43	198571.1000	37
192017.1500	68	193171.1000	31	198005.1000	49	198216.1000	48	198410.1000	45	198580.1000	47
192017.2000	68	193240.1000	29	198006.1000	39	198217.1000	48	198411.1000	33	198581.1000	37
192018.0030	61	193241.1000	29	198010.1000	49	198220.1000	53	198412.1000	43	198628.1000	53
192018.0060	61	193242.1000	29	198011.1000	39	198240.1000	53	198413.1000	33	198700.1000	53
192018.0100	61	193243.1000	29	198015.1000	48	198245.1000	36	198414.1000	43	198730.1000	49
192018.0150	61	193244.1000	29	198020.1000	48	198248.1000	49	198415.1000	33	198731.1000	39
192018.0200	61	193245.1000	29	198025.1000	49	198249.1000	49	198416.1000	43	198735.1000	49
192018.0500	61	193246.1000	29	198026.1000	39	198250.1000	53	198417.1000	33	198740.1000	53
192018.1000	61	193247.1000	29	198030.1000	48	198252.1000	49	198418.1000	43	198765.1000	48
192018.1500	61	193248.1000	30	198035.1000	45	198254.1000	49	198419.1000	33	198790.1000	49
192018.2000	61	193249.1000	30	198036.1000	42	198259.1000	47	198421.1000	43	198791.1000	39
192022.0100	62	193250.1000	30	198037.1000	42	198260.1000	53	198422.1000	33	198800.1000	49
192030.0100	62	193251.1000	30	198038.1000	42	198262.1000	47	198423.1000	33	198801.1000	39
192050.0100	62	193252.1000	30	198040.1000	45	198263.1000	47	198424.1000	43	198803.1000	45
192201.0100	62	193253.1000	30	198042.1000	35	198264.1000	37	198425.1000	33	198810.1000	45
192342.0100	62	193254.1000	30	198044.1000	38	198267.1000	47	198426.1000	43	198820.1000	48
192352.0100	62	193255.1000	30	198045.1000	45	198270.1000	53	198427.1000	33	198830.1000	53
192353.0100	62	193256.1000	30	198046.1000	35	198273.1000	35	198428.1000	43	198840.1000	47
192354.0100	62	193257.1000	29	198048.1000	35	198275.1000	47	198429.1000	33	198845.1000	45
192355.0100											

Part number index

Part-No	Page	Part-No	Page	Part-No	Page	Part-No	Page	Part-No	Page	Part-No	Page
198980.1000	45	465020	80	490071	101	705830	147	709746	144		
198985.1000	48	465050	80	490077	106	705832	150	709747	144		
198990.1000	49	465100	80	490105	117	706115	157	709753	145		
198991.1000	39	466020	80	490106	117	706120	155	709754	145		
198995.1000	48	466050	80	490112	115	706121	155	709759	145		
410003	75	466100	80	490113.0030	114	706167	160	709766	146		
410006	75	468020	88	490113.0060	114	707514	149	709767	146		
410010	75	468050	88	490113.0080	114	709427.0250	137	709768	146		
410015	75	468100	88	490113.0100	114	709427.0500	137	709771	141		
410020	75	469020	88	490113.0150	114	709427.0750	137	709772	141		
410050	75	469050	88	490113.0200	114	709427.1000	137	709773	139		
415020	71	469100	88	490113.0300	114	709427.1500	137	709774	139		
415050	71	471020	77	490113.0500	114	709427.2000	137	709775	139		
415100	71	471050	77	490123	95	709428.0250	136	709782	141		
416020	73	471100	77	490124	95	709428.0500	136	709789	141		
416050	73	472020	77	490125	95	709428.0750	136	709790	142		
416100	73	472050	77	490126	95	709428.1000	136	709791	142		
418003	92	472100	77	490128	109	709428.1500	136	709792	142		
418006	92	473020	78	490129	109	709428.2000	136				
418010	92	473050	78	490138	109	709441.0250	132				
418015	92	473100	78	490151	110	709441.0500	132				
418020	92	474020	73	490152	110	709441.0750	132				
418050	92	474050	73	490153	110	709441.1000	132				
420003	91	474100	73	490167	107	709441.1500	132				
420006	91	475300.0200	63	490168	107	709441.2000	132				
420010	91	475300.0500	63	490174	108	709442.0250	131				
420015	91	475300.1000	63	490175	108	709442.0500	131				
420020	91	475300.1500	63	490176	108	709442.0750	131				
420050	91	475300.2000	63	490177	108	709442.1000	131				
429003	89	475400.0030	64	490178	110	709442.1500	131				
429006	89	475400.0060	64	490190	97	709442.2000	131				
429010	89	475400.0100	64	490191	97	709443.0250	134				
429015	89	475400.0150	64	490192	97	709443.0500	134				
429020	89	475400.0200	64	490193	97	709443.0750	134				
429050	89	475400.0500	64	490194	98	709443.1000	134				
435003	93	475400.1000	64	490195	98	709443.1500	134				
435006	93	475400.1500	64	490196	98	709443.2000	134				
435010	93	475400.2000	64	490197	98	709459	135				
435015	93	475500.0200	65	490200	103	709460	135				
435020	93	475500.0500	65	490201	103	709462	135				
435050	93	475500.1000	65	490202	105	709469	135				
439003	94	477020	81	490203	105	709472	133				
439006	94	477050	81	490209	111	709473	133				
439010	94	477100	81	490210	103	709474	133				
439015	94	478020	81	490211	103	709475	133				
439020	94	478050	81	490212	104	709476	133				
439050	94	478100	81	490213	104	709477	133				
442003	90	479020	85	490214	105	709482	133				
442006	90	479050	85	490215	105	709483	133				
442010	90	479100	85	490230	118	709484	133				
442015	90	481020	71	490231	118	709485	133				
442020	90	481050	71	490238	111	709486	133				
442050	90	481100	71	492075	116	709487	133				
443020	85	482020	78	492076	116	709526	139				
443050	85	482050	78	499994	119	709527	139				
443100	85	482100	78	700217	161	709600	138				
447020	70	486020	70	700321	130	709601	138				
447050	70	486050	70	700323	130	709605	138				
447100	70	486100	70	700324	130	709606	138				
456202	79	487003	74	700374	158	709607	138				
456205	79	487006	74	700379	158	709608	138				
456210	79	487010	74	700413	127	709635	144				
456402	82	487015	74	700414	127	709636	144				
456405	82	487020	74	700435	128	709637	144				
456410	82	487050	74	700440	127	709645	144				
456502	83	488003	76	700445	127	709646	144				
456505	83	488006	76	700446	127	709647	144				
456510	83	488010	76	700464	129	709653	145				
456702	86	488015	76	700466	128	709654	145				
456705	86	488020	76	700476	128	709659	145				
456710	86	488050	76	700490	159	709666	146				
456802	87	490011	101	700491	159	709667	146				
456805	87	490012	101	700492	159	709668	146				
456810	87	490017	100	700493	159	709673	138				
458302	72	490018	100	700568	128	709674	138				
458305	72	490026	102	700577	128	709675	138				
458310	72	490028	99	700857	153	709700	139				
458402	72	490029	99	700861	152	709701	139				
458405	72	490035	96	700867	153	709705	139				
458410	72	490037	96	700881	152	709706	139				
458702	79	490038	102	700897	152	709707	139				
458705	79	490054	106	700910	153	709708	139				
458710	79	490057	96	701533	156	709709.0250	140				
458802	83	490059	96	701534	156	709709.0500	140				
458805	83	490060	112	701583	129	709709.1000	140				
458810	83	490061	112	705141	154	709715	143				
458902	87	490062	112	705341	154	709716	143				
458905	87	490063	112	705509	148	709717	143				
458910	87	490064	113	705610	151	709725	143				
462020	84	490065	113	705709	151	709726	143				
462050	84	490066	113	705800	147	709727	143				
462100	84	490067	113	705801	147	709735	144				
464020	84	490068	113	705803	150	709736	144				
464050	84	490069	113	705810	147	709737	144				
464100	84	490070	100	705812	150	709745	144				

Copyright

Protected trademarks and trade names are not always labelled as such in this publication. This does not mean they are free names as defined in the trademark and brand mark law. Publication does not imply that the descriptions or pictures used are free from rights of third parties. The information is published without regard to possible patent protection. Trade names are used without any guarantee that they can be used freely. In putting together text, pictures and data, we proceeded with the greatest care. Despite this, the possibility of errors cannot be completely excluded. We therefore reject any legal responsibility or liability. We are, of course, grateful for any recommendations for improvement or information useful for making corrections or establishing the truth. But the author does not assume any responsibility for the content of these documents.

Cable Solutions

High flexing cables for industrial applications

Connectivity Solutions

Industrial Ethernet, assembled cables, Actuator Sensor Interface, connectors and suppression technology

Cabinet Solutions

AirSTREAM complete system for thermally optimized and space-saving cabinet wiring

Control Solutions

Industrial Power Supply and electronic current control for Industrial Internet of Things. Infrastructure for industrial networks, signal converter, relays and modular electronics housing

Transportation Solutions

Solutions for the exacting Railway Sector, for example control technology, Interface solutions and signalling

Germany

Friedrich Lütze GmbH
Postfach 12 24 (PLZ 71366)
Bruckwiesenstraße 17-19
D-71384 Weinstadt
Tel.: +49 71 51 60 53-0
Fax: +49 71 51 60 53-277(-288)
info@luetze.de

United Kingdom

LÜTZE Ltd.
Unit 3 Sandy Hill Park
Sandy Way, Amington
Tamworth, Staffs, B77 4DU
Tel.: +44 1827 313330
Fax: +44 1827 313332
sales.gb@lutze.co.uk

Austria

LÜTZE Elektrotechnische
Erzeugnisse Ges.m.b.H.
office@luetze.at

Switzerland

LÜTZE AG
info@luetze.ch

France

LUTZE SASU
info@lutze.fr

Spain

LUTZE, S.L.
info@lutze.es

China

Luetze Trading (Shanghai) Co.Ltd.
info@luetze.cn



RoHS



Carbon neutral
Print product
ClimatePartner.com/12146-2204-1010



www.luetze.com

